



WHITMYER HEADRESTS

SUPERIOR CLINICAL SUPPORT

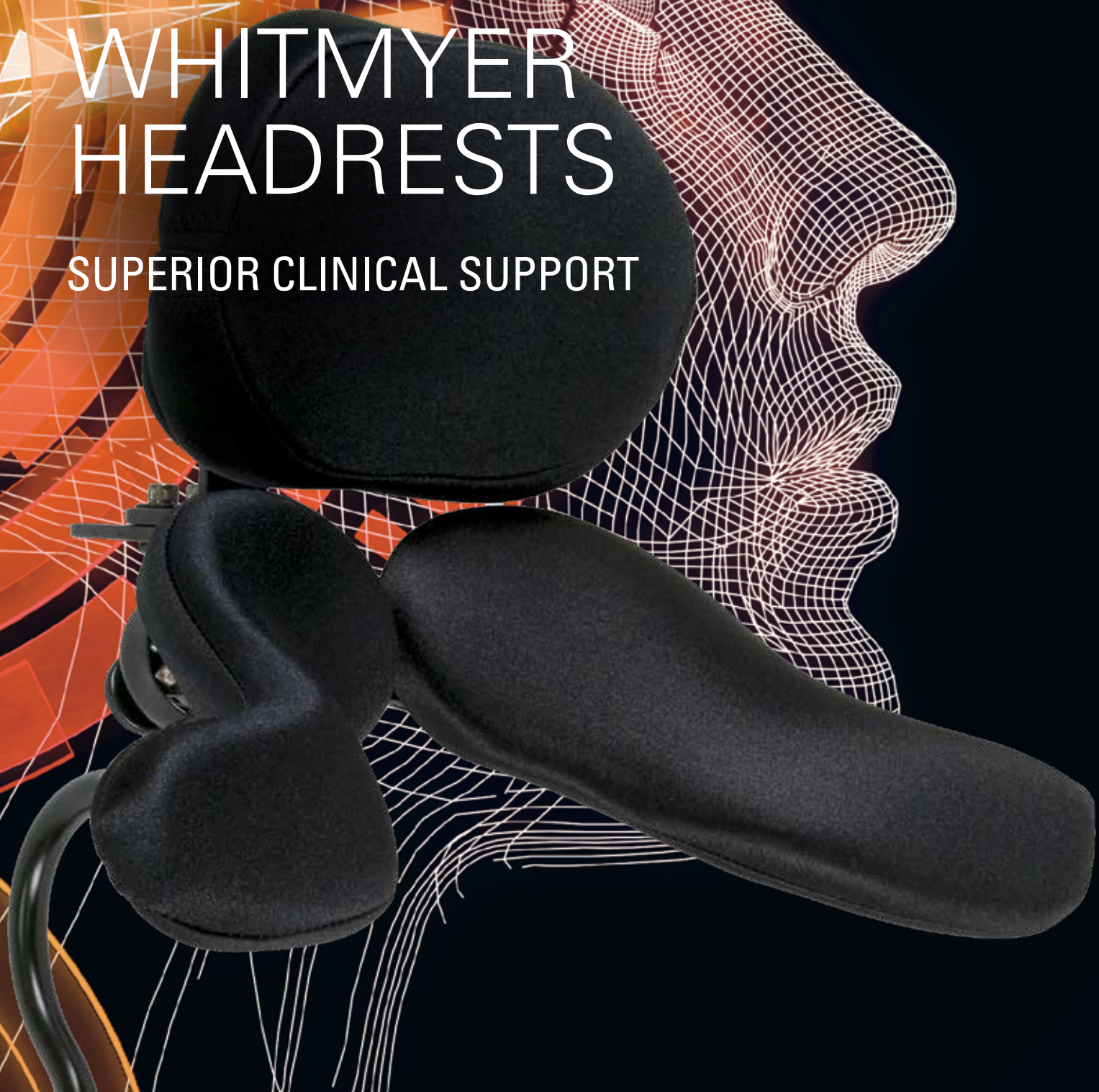



TABLE OF CONTENTS



UNDERSTANDING OUR CATALOGUE	4
WHITMYER FEATURES	6
GUIDE TO USING OUR PRODUCTS	7
WHITMYER RANGE OF HEADRESTS	8
RANGE OF MOUNTING SYSTEMS	12
HEAD SUPPORT SYSTEMS	
PLUSH Single Pad Head Support Systems and Accessories	14
Specialty PLUSH Single Pad Head Support Systems and Accessories	16
Contoured Cradle Head Support Systems and Accessories	18
S.O.F.T. Single Sub-occipital Head Support Systems and Accessories	20
S.O.F.T. Adult Head Support Systems and Accessories	22
S.O.F.T. Paediatric Head Support Systems and Accessories	24
Cuddles Infant Head Support Systems	26
HEADS UP Head Support Systems	28
CUSTOM SOLUTIONS	
Custom Solutions Options & Accessories	31
Custom Solutions Mounting Options	33
TECH INFOS	
Tech Info AXYS Mounting System	34
Tech Info LINX Mounting System	35
Tech Info PRO Mounting System	36
Tech Info COBRA XTRA Flip Back Mounting System	37
Tech Info ONYX Mounting System	38
Tech Info COBRA Mounting System	39
Tech Info PLUSH Pads	40
Tech Info Specialty PLUSH Pads	41
Tech Info Occipital and Contoured Cradle Pads	42
Tech Info Sub-occipital & Single Sub-occipital Pads	43
Tech Info S.O.F.T. Base Plate Assembly	44
REPLACEMENT PARTS	
Replacement Parts Anterior Supports & LF Components	45
Replacement Parts Foams & Covers	46

UNDERSTANDING OUR CATALOGUE

CONFIGURED SYSTEM PAGES

In an effort to simplify the ordering process, our Head Support Systems pages are laid out so that you can order a complete system with accessories without ever having to turn a page. Systems are divided by pad configuration.

Left Page

Allows you to select:

Pad Configuration →

Mounting System →

Mounting Bracket →

PLUSH | Single Pad Head Support Systems

STEP 1















Select Pad Size and Mounting System. Detailed pad dimensions are located on page 35.

STEP 2

Use table to identify headrest part numbers.

STEP 3

Select mounting bracket to complete headrest system. Example: PRO-P4L and M2200-WB. Exception: Cobra XTRA Systems.

STEP 1					
					
	480 mm	350 mm	250 mm	200 mm	150 mm
MOUNTING SYSTEM		AXYS	LINX	PRO	COBRA XTRA FLIP BACK
					
PAD SIZE		HEAD SUPPORT PART NUMBER			
	480 mm	AXYS-P4L	LINX-P4L	PRO-P4L	FB-Cobra-P4L
	350 mm	AXYS-P2L	LINX-P2L	PRO-P2L	FB-Cobra-P2L
	250 mm	AXYS-P1L	LINX-P1L	PRO-P1L	FB-Cobra-P1L
	200 mm	AXYS-P3L	LINX-P3L	PRO-P3L	FB-Cobra-P3L
	150 mm	AXYS-P8L	LINX-P8L	PRO-P8L	FB-Cobra-P8L
MOUNTING BRACKET					
				This system includes detachable mounting bracket and has a swing away function	
	Detachable	M2500	M2300	M2200-WB	
				This system includes detachable mounting bracket and has a swing away function	
	Swing away	M5500	M5300	M5200	

Right Page

Select accessories:

Lateral facial supports →

Anterior support options →

PLUSH | Lateral Facial Supports

STEP 4A

Select pad contour and size.

STEP 5A

Use table to identify Lateral Facial Support Options and part numbers.



Unilateral



Bilateral

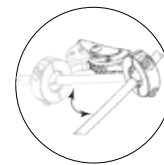

NOTE: All Lateral Supports come with swing away hardware

		SPOT	STANDARD	LONG	OVAL	LARGE-C	MEDIUM-C	SMALL-C
STEP 4A								
		LATERAL FACIAL SUPPORT PART NUMBER						
STEP 5A	UNILATERAL SUPPORT OPTION	LFC10-PLL	LFC15-PLL	LFC20-PLL	LFC25-PLL	LFC30-PLL	LFC35-PLL	LFC40-PLL
	BILATERAL SUPPORT OPTION	LFC10-PL2L	LFC15-PL2L	LFC20-PL2L	LFC25-PL2L	LFC30-PL2L	LFC35-PL2L	LFC40-PL2L

PLUSH | Anterior Support Options

STEP 4B

Select Anterior Support Option.

STEP 5B

Use table to select size/colour and to identify Anterior Support Option part numbers.

		DYNAMIC FOREHEAD STRAP	DFS ¹	STRAP CAP	HEDZ-UP
STEP 4B					
STEP 5B	ADULT ¹	DFS10	DFSQ10	CAP10 (black)	HU10
	PAEDIATRIC ¹	DFS30	DFSQ30	CAP30-R (red) CAP30-B (blue)	HU10

¹ Anterior supports are not compatible with 480 mm PLUSH systems and have limited results with 350 mm PLUSH systems.

WHITMYER FEATURES

Each design feature addresses a specific support purpose.

Occipital Pad:

Provides posterior support to the occipital of the skull.

Sub-Occipital Pads:

Provide proximal stability to head.

Lateral Design of Sub-Occipital Pads:

Provide lateral support to the neck, not the jaw!

Flared Tabs:

Provide protection against client getting "hooked" around edge of head support.

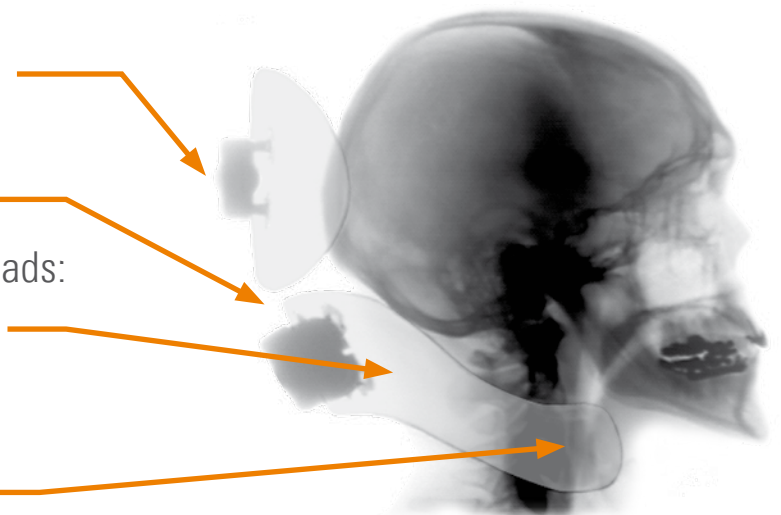

- **Variety of pad shapes and sizes:**
 - Single pad systems provide basic support against gravity with moderate control features.
 - Single Sub-occipital pad systems provide easier adjustment.
 - S.O.F.T. three pad systems are for clients with very complex needs.
- **Mounting system choices** provide a wide range of adjustment and positioning possibilities. All Mounting Systems are designed to be durable and cosmetically appealing.
- **Knurled balls** guarantee secure clamping and prevent pads from slipping out of adjustment.
- **Universal ball & socket size** allow you to customise your client's head support with off-the-shelf products.
- **Swing away mounting upgrades** move the head support out of the way for transfers while keeping the head support unit attached to the chair.
- **Accessory components** provide lateral and/or anterior support solutions for more complex positioning needs.
- **Anterior support components:** Dynamic movement allows freedom of rotational movement while providing support.
- **Static forehead strap unit** acts as a perimeter support for individuals who resist constant contact.
- **Lateral facial components** with a rearward pivot point provide more clearance during transfers and/or periods of non-use of switches/pads.
- **Adaptor plates** allow for easy integration of all Whitmyer accessories with single pad systems.

GUIDE TO USING OUR PRODUCTS



Set Realistic Goals

No head support system will fix seating issues! Head support is an integral part of seating & positioning, not an accessory. Set obtainable goals for seating, positioning, and head support so your client can achieve optimal positioning. When available, use simulation to help determine the equipment needed to achieve these goals.



Evaluate Overall Condition

Determine your client's orthopedic condition by performing a complete mat evaluation in sitting and supine positions. Evaluate the following to determine the degree of head support needed:

- Lateral flexion and rotation
- Tonal patterns
- Tolerance of contact or pressure
- Muscle strength or weakness
- Amount of force necessary to accommodate/correct.

Determine the degree of support your client will tolerate. In some cases, it is better to forego aggressive head support equipment and achieve consistency of use or positioning.

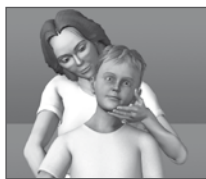

Get Hands-on!

Simulate head position with your hands. Assess the forces necessary to obtain the head positioning goals. Note the direction and the amount of force you apply, monitoring the degree of active movement or resistance from the client. Consider the client's head size/shape and how much surface area will be available for pressure distribution.



Select Proper Components

Select the head support and options that best mimic the forces and shapes of your hands during the mat evaluation. Consider the need for support surfaces:

- One, two, three or more pads for support?
- Choices of lateral, anterior, posterior options?
- Lateral or rotational accommodation?
- Dynamic or static support?



Areas to Avoid with Direct Pressure

Avoid direct pressure at these points:

- Temporal area and eyes
- Ears
- Mastoid process (bony prominence behind ear)
- Mandible or jawbone.

Areas To Support

Cradle the inferior surface of the occiput as much as possible. Look for flat areas on the side of the head, face, or forehead to support.

Mounting Position

Remember, the influence of orthopedic issues may affect your client's ability to achieve midline head positioning. Consider mounting the head support off midline to better follow the neck in reference to the shoulders.

WHITMYER RANGE OF HEADRESTS

PLUSH



Single Pad Head Support

PLUSH Single Pad Headrest Systems utilise dual density foam layers on a contoured, curved panel. These single pad headrests are easily adjustable and accommodate changes or inconsistencies in body positioning. Unique “cupping” shape provides posterior support with a high degree of comfort and safety. This basic headrest is ideal for tilt/recline, and has the ability to add lateral support, anterior support, or switches as client’s needs change. The larger size pads facilitate safety for clients with behavioral issues and active movements.



SPECIALTY PLUSH



Single Pad Head Support

Specialty PLUSH Single Pad Headrest Systems formerly available only as custom ordered products, are now in-stock and ready-to-ship! Dual Mount 480 mm & 350 mm PLUSH pads may be ideal for high tone, high extension clients. The 300 mm Narrow PLUSH pad offers low profile support. The adjust A Plush has two tapered locking points that can be narrowed or widened to provide maximum lateral support. Zippered cover hides adjustment points.



WHITMYER RANGE OF HEADRESTS

CONTOURED CRADLE



Head Support

Contoured Cradle Head Supports positioning success is derived from its unique anatomic shape. Generically designed to cradle the occiput and provide lateral cervical support, this unit supplies a high degree of comfort and positioning in a simple-to-adjust head support. A single rotational collar adjustment allows positioning for maximum support surface contact. Six pad sizes fit infant to adult. Add lateral facial pads, switches, and/or anterior support for more versatility.



S.O.F.T. SINGLE SUB-OCCIPITAL



Head Support

S.O.F.T. Single Sub-occipital Head Supports supply sub-occipital and proximal lateral cervical support via a single curved sub-occipital pad. This more generically shaped pad allows for quick adjustments. Unique to our single sub-occipital system is the independent anterior/posterior occipital pad movement. Consistent, repeatable positioning of the client is required for best performance. The addition of lateral facial pads, switches and anterior supports increase this system's versatility.



WHITMYER RANGE OF HEADRESTS

S.O.F.T. ADULT + PAEDIATRIC



Head Support

S.O.F.T. Three Pad Head Supports solve the most challenging head positioning issues. This patented three pad device combines two width and rotationally adjustable sub-occipital pads with an adjustable occipital pad for independent anterior/posterior movement. The added adjustability of the individual sub-occipital pads allows adjustment to asymmetrical postures and deformities. This unique pad configuration supplies maximum occipital and proximal lateral cervical support for more aggressive positioning and comfort. Consistent, repeatable positioning of the client is required for best performance. Attaching lateral facial pads, switches, and/or anterior supports adds to this system's versatility.



CUDDLES INFANT



Head Support

CUDDLES INFANT Headrest utilises the same pads and support assembly as the S.O.F.T. Paediatric Head support system but provides a unique soft and gentle fleece cover.

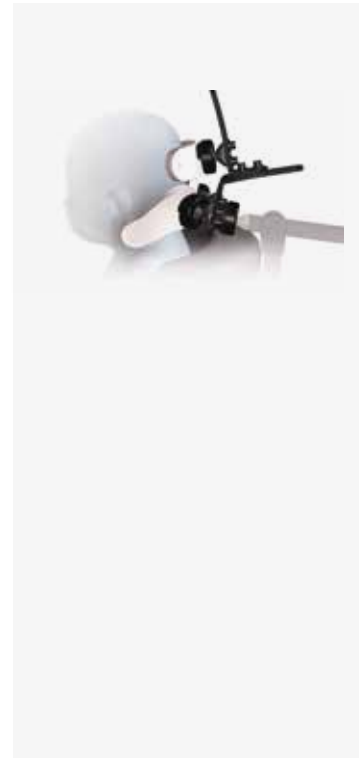

WHITMYER RANGE OF HEADRESTS

HEADS UP



Anterior Head Support

HEADS UP – This innovative anterior head support system has been designed to maximise clients' interaction with their environment by providing anterior, posterior and lateral support of the head and neck. It features swing-out, adjustable arms to easily accommodate client transfers and varying client presentations.



HEADREST ACCESSORIES



Lateral Facial Pads

Lateral Facial Pads can be configured to accommodate or block lateral flexion deviations and/or rotation patterns or function to supply general support surfaces or switch placement above the cervical level. A rearward mounting hardware pivot point allows the pads to move out-of-the-way during transfers or when not in use. Curved ball rods allow placement of pads around the head laterally or anteriorly. A choice of 7 uniquely shaped pad sizes, 5 of which are malleable; ensure the ability to match the pad with the area needing support.



Choice of Anterior Supports

Choice of Anterior Supports – The patented Dynamic Forehead Strap facilitates upright head support and freedom of rotational movement. Excellent for low tone individuals with poor head balance, individuals exhibiting forward flexion patterns, or individuals who require an upright head position for medical reasons, i.e. compromised respiration and swallowing. Successfully used for task oriented applications, such as classroom interaction or during meals. The addition of a Strap Cap brings a low profile solution to anterior support for individuals who may not be successful with the strap. As an alternative, The Hedz-Up Static Forehead Strap was designed as a perimeter strap to limit the extent of forward/lateral movement. Correctly adjusting the strap off the forehead allows this movement range. Adjustable angle pivot brackets stop downward strap motion and supply a consistent strap position. People with ALS, MS, and MD are excellent candidates for the Hedz-Up. When utilising anterior support options, repeatable positioning of the client is required for best performance.

RANGE OF MOUNTING SYSTEMS

AXYS MOUNTING SYSTEM



The AXYS Mounting System is a proven, economical hardware option. A black chrome finish combined with a small profile steel square rod presents a compact, aesthetically pleasing mounting solution.

Designed for ease of adjustment, and simple modifications. This system is compatible with all Whitmyer accessories.

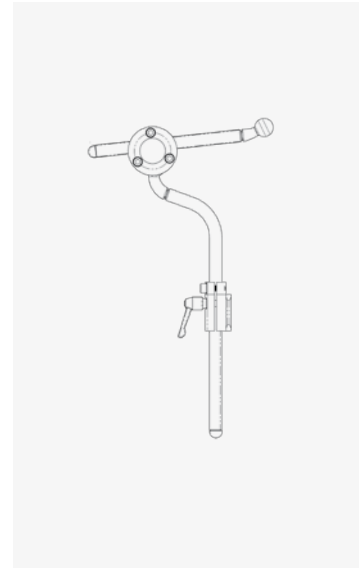

LINX MOUNTING SYSTEM



The LINX Mounting System features the latest concept in contemporary head support mounting hardware. Combining two simple, unique points of adjustment allows full anterior/posterior fluid movement, creating an infinite range of support surface placement. Satin black tubing with contrasting polished aluminum clamps and knurled mounting ball ensures stay-in-place adjustments with a stylish look.

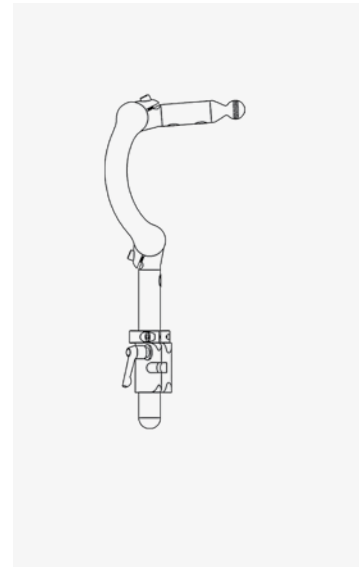

PRO MOUNTING SYSTEM



The PRO Mounting System is a proven hardware option for demanding applications. This Mounting System is ideal for use when client strength or strong tonal patterns are an issue. Perfect for institutional environments.

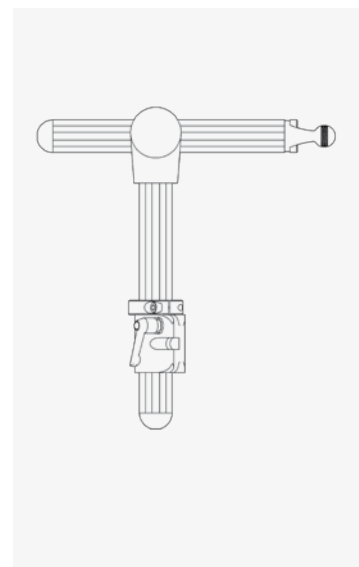

RANGE OF MOUNTING SYSTEMS

COBRA XTRA FLIP BACK MOUNTING SYSTEM



The COBRA XTRA Flip Back Mounting System

is operated by a single push-button on the side of the bracket and neatly flips the assembly back behind the wheelchair back. With superior strength and positioning range, the COBRA XTRA Flip Back Mounting System is available in Small (Early Intervention and Paediatric), Medium (Paediatric), and Large (Adult). The components are modular and easily changed in the field to enable exact positioning of the head support pad – even if the user's head position changes from the time of the initial prescription.



ONYX MOUNTING SYSTEM



The ONYX Mounting System is a compact solution that features a black chrome finish combined with a small profile steel rod. It was designed for, ease of adjustment and simple modifications.



COBRA MOUNTING SYSTEM



The COBRA Mounting System incorporates a sleek and unobtrusive design that eliminates protrusion toward the rear of the chair. With a superior strength and positioning range, the COBRA is available in three sizes. The components are modular and easily changed in the field to enable exact positioning of the support pad, even if the user's head position changes over time.

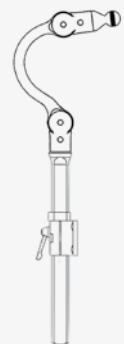

PLUSH | Single Pad Head Support Systems

STEP 1

Select Pad Size and Mounting System. Detailed pad dimensions are located on page 40.

STEP 2

Use table to identify headrest part numbers.

STEP 3

Select mounting bracket to complete headrest system. Example: PRO-P4L and M2200-WB Exception: Cobra XTRA Systems.

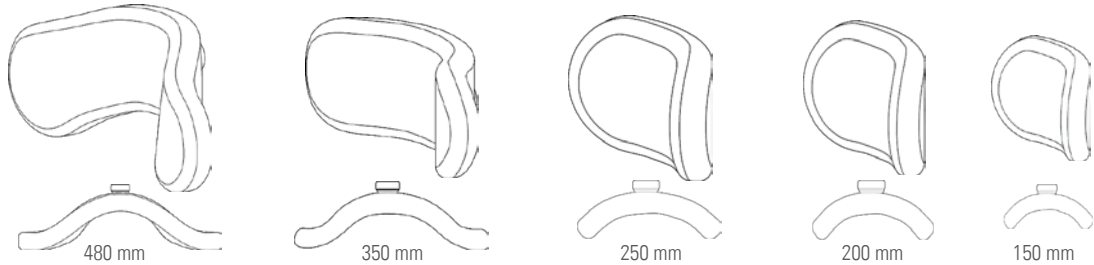

STEP 1	MOUNTING SYSTEM				
	AXYS	LINX	PRO	COBRA XTRA FLIP BACK	
STEP 2	PAD SIZE	HEAD SUPPORT PART NUMBER			
	480 mm	AXYS-P4L	LINX-P4L	PRO-P4L	FB-Cobra-P4L
	350 mm	AXYS-P2L	LINX-P2L	PRO-P2L	FB-Cobra-P2L
	250 mm	AXYS-P1L	LINX-P1L	PRO-P1L	FB-Cobra-P1L
	200 mm	AXYS-P3L	LINX-P3L	PRO-P3L	FB-Cobra-P3L
	150 mm	AXYS-P8L	LINX-P8L	PRO-P8L	FB-Cobra-P8L
STEP 3	MOUNTING BRACKET				
					This system includes detachable mounting bracket.
	Detachable	M2500	M2300	M2200-WB	
					This system includes detachable mounting bracket and has a swing away function
Swing away	M5500	M5300	M5200		

PLUSH | Lateral Facial Supports

STEP 4A

Select pad contour and size.

STEP 5A

Use table to identify Lateral Facial Support Options and part numbers.

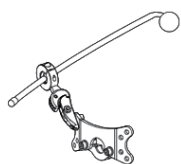

Unilateral

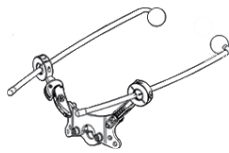

Bilateral

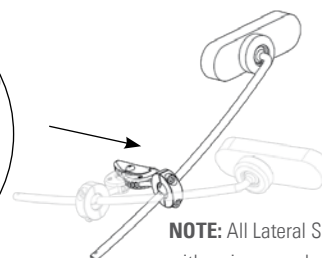
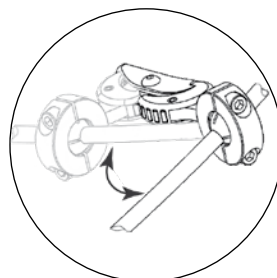

NOTE: All Lateral Supports come with swing away hardware

		SPOT	STANDARD	LONG	OVAL	LARGE-C	MEDIUM-C	SMALL-C
STEP 4A								
STEP 5A	LATERAL FACIAL SUPPORT PART NUMBER							
	UNILATERAL SUPPORT OPTION	LFC10-PLL	LFC15-PLL	LFC20-PLL	LFC25-PLL	LFC30-PLL	LFC35-PLL	LFC40-PLL
	BILATERAL SUPPORT OPTION	LFC10-PL2L	LFC15-PL2L	LFC20-PL2L	LFC25-PL2L	LFC30-PL2L	LFC35-PL2L	LFC40-PL2L

PLUSH | Anterior Support Options

STEP 4B

Select Anterior Support Option.

STEP 5B

Use table to select size/colour and to identify Anterior Support Option part numbers.

		DYNAMIC FOREHEAD STRAP	DFS ²	STRAP CAP	HEDZ-UP
STEP 4B					
STEP 5B	ADULT ¹	DFS10	DFSQ10	CAP10 (black)	HU10
	PAEDIATRIC ¹	DFS30	DFSQ30	CAP30-R (red) CAP30-B (blue)	HU10

¹ Anterior supports are not compatible with 480 mm PLUSH systems and have limited results with 350 mm PLUSH systems.

SPECIALTY PLUSH | Single Pad Head Support Systems¹

STEP 1

Select Pad Size and Mounting System. Detailed pad dimensions are located on page 40.

STEP 2

Use table to identify headrest part numbers.

STEP 3

Select mounting bracket to complete headrest system. Example: PRO-P44L and M2200-WB Exception: Cobra XTRA Systems.

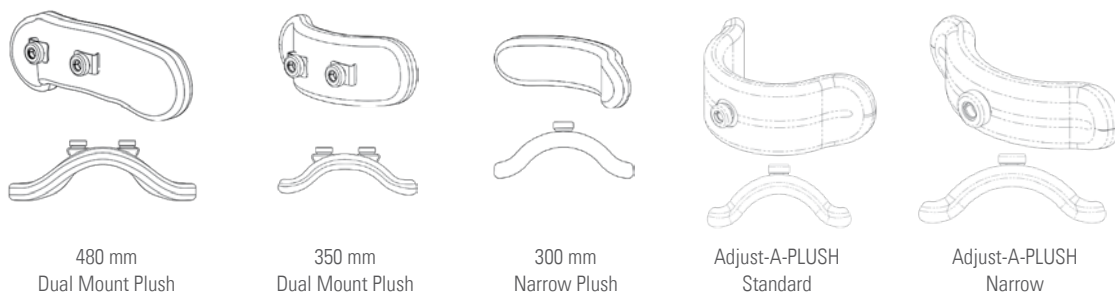

STEP 1	STEP 2				
		AXYS	LINX	PRO	COBRA XTRA FLIP BACK
	MOUNTING SYSTEM				
STEP 2	PAD SIZE	HEAD SUPPORT PART NUMBER			
	480 mm Dual Mount PLUSH ²	AXYS-P44L	LINX-P44L	PRO-P44L	-
	350 mm Dual Mount PLUSH ²	AXYS-P22L	LINX-P22L	PRO-P22L	-
	300 mm Narrow PLUSH	AXYS-P12L	LINX-P12L	PRO-P12L	FB-Cobra-P12L
	Adjust-A-PLUSH Narrow	AXYS-AP1L	LINX-AP1L	PRO-AP1L	FB-Cobra-AP1L
Adjust-A-PLUSH Standard	AXYS-AP2L	LINX-AP2L	PRO-AP2L	FB-Cobra-AP2L	
STEP 3	MOUNTING BRACKET				
					This system includes detachable mounting bracket.
	Detachable	M2500	M2300	M2200-WB	
					This system includes detachable mounting bracket and has a swing away function
Swing away	M5500	M5300	M5200		

¹ NOTE: Pads are not scaled proportionally. See page 41 for pad dimensions.

² 480 mm and 350 mm Dual Mount PLUSH Systems require two mounting brackets. Swing away option is not recommended.

SPECIALTY PLUSH | Lateral Facial Supports

STEP 4A

Select pad contour and size.

STEP 5A

Use table to identify Lateral Facial Support Options and part numbers.

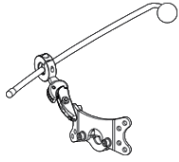

Unilateral



Bilateral

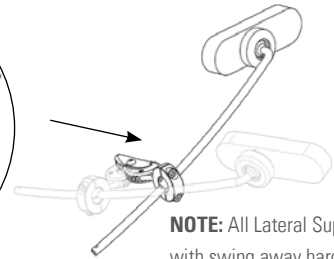
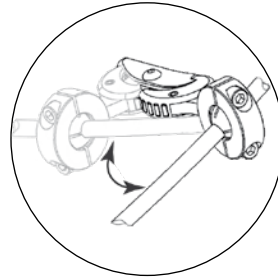

NOTE: All Lateral Supports come with swing away hardware

		SPOT	STANDARD	LONG	OVAL	LARGE-C	MEDIUM-C	SMALL-C
STEP 4A								
STEP 5A	LATERAL FACIAL SUPPORT PART NUMBER							
	UNILATERAL ¹ SUPPORT OPTION	LFC10-PLL	LFC15-PLL	LFC20-PLL	LFC25-PLL	LFC30-PLL	LFC35-PLL	LFC40-PLL
	BILATERAL ¹ SUPPORT OPTION	LFC10-PL2L	LFC15-PL2L	LFC20-PL2L	LFC25-PL2L	LFC30-PL2L	LFC35-PL2L	LFC40-PL2L

SPECIALTY PLUSH | Anterior Support Options

STEP 4B

Select Anterior Support Option.

STEP 5B

Use table to select size/colour and to identify Anterior Support Option part numbers.

		DYNAMIC FOREHEAD STRAP	DFS ²	STRAP CAP	HEDZ-UP
STEP 4B					
STEP 5B	ADULT ^{1,2}	DFS10	DFSQ10	CAP10 (black)	HU10
	PAEDIATRIC ^{1,2}	DFS30	DFSQ30	CAP30-R (red) CAP30-B (blue)	HU10

¹ Lateral Facial Supports are not recommended for use with Dual Mount PLUSH Systems.

² Anterior supports are not compatible with Dual Mount PLUSH systems.

CONTOURED CRADLE | Head Support Systems

STEP 1

Select Pad Size and Mounting System. Detailed pad dimensions are located on pages 42 and 43.

STEP 2

Use table to identify headrest part numbers.

STEP 3

Select mounting bracket to complete Head Support system. Example: PRO-CCS4L and M2200-WB Exception: Cobra XTRA Systems.

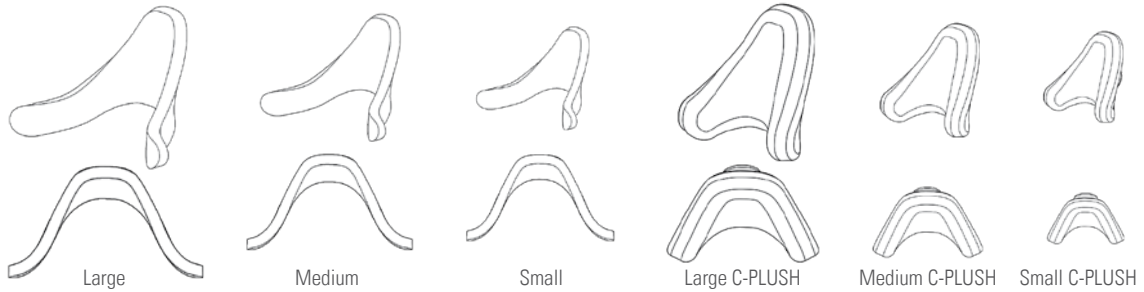

STEP 1

	AXYS	LINX	PRO	COBRA XTRA FLIP BACK
MOUNTING SYSTEM				

STEP 2

PAD SIZE	HEAD SUPPORT PART NUMBER			
Large	AXYS-CCS4L	LINX-CCS4L	PRO-CCS4L	FB-Cobra-CCS4L
Medium	AXYS-CCS3L	LINX-CCS3L	PRO-CCS3L	FB-Cobra-CCS3L
Small	AXYS-CCS2L	LINX-CCS2L	PRO-CCS2L	FB-Cobra-CCS2L
C-PLUSH Large	AXYS-CCP4L	LINX-CCP4L	PRO-CCP4L	FB-Cobra-CCP4L
C-PLUSH Medium	AXYS-CCP3L	LINX-CCP3L	PRO-CCP3L	FB-Cobra-CCP3L
C-PLUSH Small	AXYS-CCP2L	LINX-CCP2L	PRO-CCP2L	FB-Cobra-CCP2L

STEP 3

	MOUNTING BRACKET			
				This system includes detachable mounting bracket.
Detachable	M2500	M2300	M2200-WB	
				This system includes detachable mounting bracket and has a swing away function
Swing away	M5500	M5300	M5200	

CONTOURED CRADLE | Lateral Facial Supports

STEP 4A

Select pad contour and size.

STEP 5A

Use table to identify Lateral Facial Support Options and part numbers.

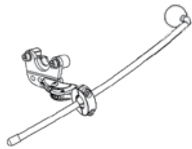

Unilateral

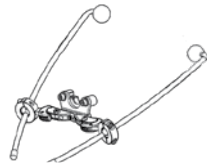

Bilateral

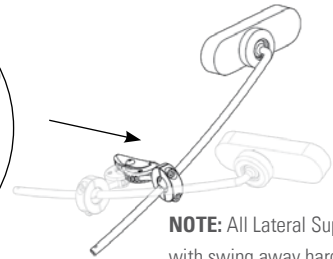
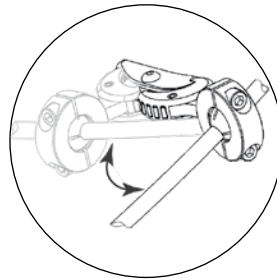

NOTE: All Lateral Supports come with swing away hardware

		SPOT	STANDARD	LONG	OVAL	LARGE-C	MEDIUM-C	SMALL-C
STEP 4A								
STEP 5A	LATERAL FACIAL SUPPORT PART NUMBER							
	UNILATERAL SUPPORT OPTION	LFC10-CSL	LFC15-CSL	LFC20-CSL	LFC25-CSL	LFC30-CSL	LFC35-CSL	LFC40-CSL
	BILATERAL SUPPORT OPTION	LFC10-CS2L	LFC15-CS2L	LFC20-CS2L	LFC25-CS2L	LFC30-CS2L	LFC35-CS2L	LFC40-CS2L

SPECIALTY PLUSH | Anterior Support Options

STEP 4B

Select Anterior Support Option.

STEP 5B

Use table to select size/colour and to identify Anterior Support Option part numbers.

		DYNAMIC FOREHEAD STRAP	DFS ²	STRAP CAP	HEDZ-UP
STEP 4B					
STEP 5B	ADULT	DFS10	DFSQ10	CAP10 (black)	HU10
	PAEDIATRIC	DFS30	DFSQ30	CAP30-R (red) CAP30-B (blue)	HU10

S.O.F.T. SINGLE SUB-OCCIPITAL | Head Support Systems

STEP 1

Select Pad Size and Mounting System. Detailed pad dimensions are located on page 40-43.

STEP 2

Use table to identify Head Support part numbers.

STEP 3

Select mounting bracket to complete head support system. Example: PRO-SS10L and M2200-WB Exception: Cobra XTRA Systems.



SS10

250 mm PLUSH occipital w/
Adult Single Sub-occipital.



SS8

Adult occipital w/
Adult Single Sub-occipital.

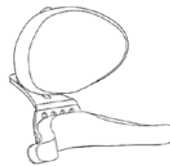

SS4

Adult occipital w/
Paediatric Single Sub-occipital.

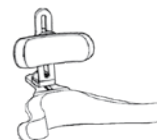

SS3

Paediatric occipital w/
Paediatric Single Sub-occipital.

STEP 1	MOUNTING SYSTEM				
	AXYS	LINX	PRO	COBRA XTRA FLIP BACK	
STEP 2	PAD SIZE	HEAD SUPPORT PART NUMBER			
	SS10	AXYS-SS10L	LINX-SS10L	PRO-SS10L	FB-Cobra-SS10L
	SS8	AXYS-SS8L	LINX-SS8L	PRO-SS8L	FB-Cobra-SS8L
	SS4	AXYS-SS4L	LINX-SS4L	PRO-SS4L	FB-Cobra-SS4L
	SS3	AXYS-SS3L	LINX-SS3L	PRO-SS3L	FB-Cobra-SS3L
STEP 3	MOUNTING BRACKET				
					This system includes detachable mounting bracket.
	Detachable	M2500	M2300	M2200-WB	
					This system includes detachable mounting bracket and has a swing away function
Swing away	M5500	M5300	M5200		

S.O.F.T. SINGLE SUB-OCCIPITAL | Lateral Facial Supports

STEP 4A

Select pad contour and size.

STEP 5A

Use table to identify Lateral Facial Support Options and part numbers.

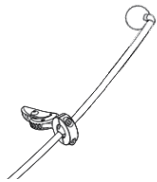



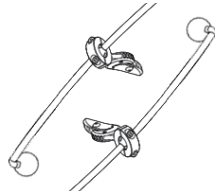

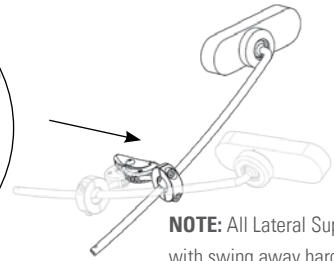
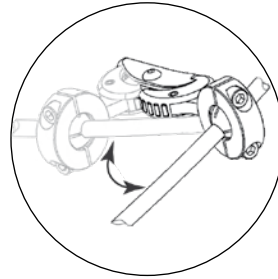

Unilateral



Bilateral



NOTE: All Lateral Supports come with swing away hardware

		SPOT	STANDARD	LONG	OVAL	LARGE-C	MEDIUM-C	SMALL-C
STEP 4A								
		LATERAL FACIAL SUPPORT PART NUMBER						
STEP 5A	UNILATERAL SUPPORT OPTION	LFC10L	LFC15L	LFC20L	LFC25L	LFC30L	LFC35L	LFC40L
	BILATERAL SUPPORT OPTION	(2) LFC10L	(2) LFC15L	(2) LFC20L	(2) LFC25L	(2) LFC30L	(2) LFC35L	(2) LFC40L

S.O.F.T. SINGLE SUB-OCCIPITAL | Anterior Support Options

STEP 4B

Select Anterior Support Option.

STEP 5B

Use table to select size/colour and to identify Anterior Support Option part numbers.

		DYNAMIC FOREHEAD STRAP	DFS ²	STRAP CAP	HEDZ-UP
STEP 4B					
STEP 5B	ADULT	DFS1	DFSQ1	CAP1 (black)	HU1
	PAEDIATRIC	DFS3	DFSQ3	CAP3-R (red) CAP3-B (blue)	HU1

S.O.F.T. ADULT | Head Support Systems

STEP 1

Select Pad Size and Mounting System. Detailed pad dimensions are located on page 40-43.

STEP 2

Use table to identify Head Support part numbers.

STEP 3

Select mounting bracket to complete head support system. Example: PRO-8L and M2200-WB Exception: Cobra XTRA Systems.



5
250 mm PLUSH Occipital w/
Size-1 Sub-occipitals





8
200 mm PLUSH Occipital w/
Size-1 Sub-occipitals



2
Adult Occipital w/
Size-2 Sub-occipitals

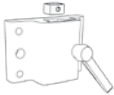

1
Adult Occipital w/
Size-1 Sub-occipitals

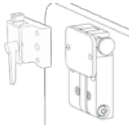
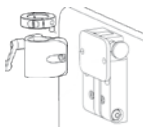
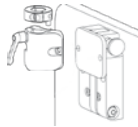
STEP 1	MOUNTING SYSTEM				
	AXYS	LINX	PRO	COBRA XTRA FLIP BACK	
STEP 2	PAD SIZE	HEAD SUPPORT PART NUMBER			
	8	AXYS-8L	LINX-8L	PRO-8L	FB-Cobra-8L
	5	AXYS-5L	LINX-5L	PRO-5L	FB-Cobra-5L
	2¹	AXYS-2L	LINX-2L	PRO-2L	FB-Cobra-2L
	1	AXYS-1L	LINX-1L	PRO-1L	FB-Cobra-1L
STEP 3	MOUNTING BRACKET				
					This system includes detachable mounting bracket.
	Detachable	M2500	M2300	M2200-WB	
STEP 3					This system includes detachable mounting bracket and has a swing away function
	Swing away	M5500	M5300	M5200	

¹ Size-2 Sub-occipital pads are recommended for use with individuals exhibiting better tone and head control.

S.O.F.T. ADULT | Lateral Facial Supports

STEP 4A

Select pad contour and size.

STEP 5A

Use table to identify Lateral Facial Support Options and part numbers.

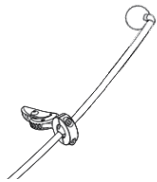

Unilateral

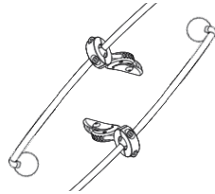

Bilateral

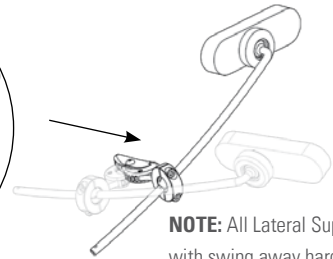
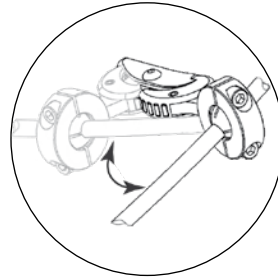

NOTE: All Lateral Supports come with swing away hardware

		SPOT	STANDARD	LONG	OVAL	LARGE-C	MEDIUM-C	SMALL-C
STEP 4A								
STEP 5A	LATERAL FACIAL SUPPORT PART NUMBER							
	UNILATERAL SUPPORT OPTION	LFC10L	LFC15L	LFC20L	LFC25L	LFC30L	LFC35L	LFC40L
	BILATERAL SUPPORT OPTION	(2) LFC10L	(2) LFC15L	(2) LFC20L	(2) LFC25L	(2) LFC30L	(2) LFC35L	(2) LFC40L

S.O.F.T. ADULT | Anterior Support Options

STEP 4B

Select Anterior Support Option.

STEP 5B

Use table to select size/colour and to identify Anterior Support Option part numbers.

		DYNAMIC FOREHEAD STRAP	DFS ²	STRAP CAP	HEDZ-UP
STEP 4B					
STEP 5B	ADULT	DFS1	DFSQ1	CAP1 (black)	HU1
	PAEDIATRIC	DFS3	DFSQ3	CAP3-R (red) CAP3-B (blue)	HU1

S.O.F.T. PAEDIATRIC | Head Support Systems

STEP 1

Select Pad Size and Mounting System. Detailed pad dimensions are located on page 40-43.

STEP 2

Use table to identify Head Support part numbers.

STEP 3

Select mounting bracket to complete head support system. Example: PRO-7L and M2200-WB Exception: Cobra XTRA Systems.



7
200 mm PLUSH Occipital w/
Size-3 Sub-occipitals

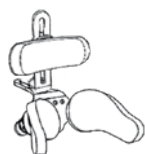

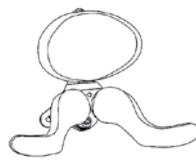

6
Paediatric Occipital w/
Size-4 Sub-occipitals

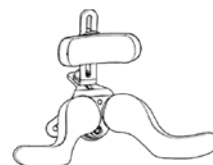

4
Adult Occipital w/
Size-3 Sub-occipitals

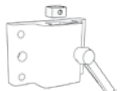

3
Paediatric Occipital w/
Size-3 Sub-occipitals

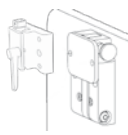
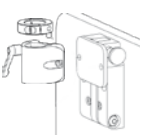
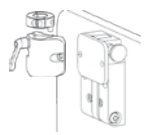
STEP 1	MOUNTING SYSTEM				
		AXYS	LINX	PRO	COBRA XTRA FLIP BACK
STEP 2	PAD SIZE	HEAD SUPPORT PART NUMBER			
	7	AXYS-7L	LINX-7L	PRO-7L	FB-Cobra-7L
	6¹	AXYS-6L	LINX-6L	PRO-6L	FB-Cobra-6L
	4	AXYS-4L	LINX-4L	PRO-4L	FB-Cobra-4L
	3	AXYS-3L	LINX-3L	PRO-3L	FB-Cobra-3L
STEP 3	MOUNTING BRACKET				
					This system includes detachable mounting bracket.
	Detachable	M2500	M2300	M2200-WB	
					This system includes detachable mounting bracket and has a swing away function
Swing away	M5500	M5300	M5200		

¹ Size-4 Sub-occipital pads are recommended for use with individuals exhibiting better tone and head control.

S.O.F.T. PAEDIATRIC | Lateral Facial Supports

STEP 4A

Select pad contour and size.

STEP 5A

Use table to identify Lateral Facial Support Options and part numbers.

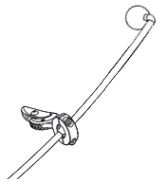

Unilateral

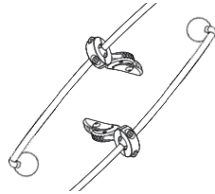

Bilateral

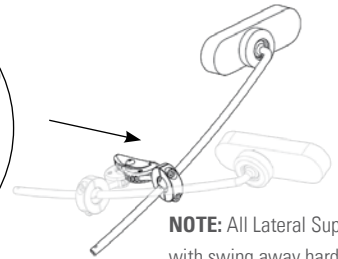
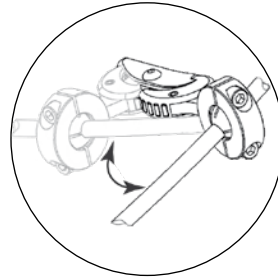

NOTE: All Lateral Supports come with swing away hardware

		SPOT	STANDARD	LONG	OVAL	LARGE-C	MEDIUM-C	SMALL-C
STEP 4A								
STEP 5A	LATERAL FACIAL SUPPORT PART NUMBER							
	UNILATERAL SUPPORT OPTION	LFC10L	LFC15L	LFC20L	LFC25L	LFC30L	LFC35L	LFC40L
	BILATERAL SUPPORT OPTION	(2) LFC10L	(2) LFC15L	(2) LFC20L	(2) LFC25L	(2) LFC30L	(2) LFC35L	(2) LFC40L

S.O.F.T. PAEDIATRIC | Anterior Support Options

STEP 4B

Select Anterior Support Option.

STEP 5B

Use table to select size/colour and to identify Anterior Support Option part numbers.

		DYNAMIC FOREHEAD STRAP	DFS ²	STRAP CAP	HEDZ-UP
STEP 4B					
STEP 5B	ADULT	DFS1	DFSQ1	CAP1 (black)	HU1
	PAEDIATRIC	DFS3	DFSQ3	CAP3-R (red) CAP3-B (blue)	HU1

CUDDLES INFANT | Head Support Systems

STEP 1

Select Pad Size and AXYS Mounting System.

STEP 2

Use table to identify headrest part numbers.

STEP 3

Select mounting bracket to complete head support system.

NOTE:

Only available with Lycra cover and AXYS Mounting System

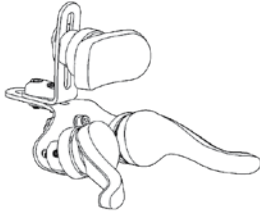

S.O.F.T. Infant Occipital w/Infant Sub-occipitals



CCS Infant Contoured Cradle Pad

STEP 1

AXYS

MOUNTING SYSTEM



PAD SIZE

HEAD SUPPORT PART NUMBER

S.O.F.T.

AXYS-INFT

STEP 2

CCS

AXYS-CCS1

MOUNTING BRACKET

STEP 3

Detachable

M2500

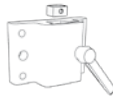

Swing away

M5500

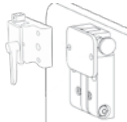



HEADS UP | Head Support Systems

The HEADS UP features easy to create smart part numbers for configuring the headrest. Follow the 6 easy steps below to generate a head support part number. The Mounting System (Step 7) and mounting bracket (Step 8) need to be ordered separately.

Example Smart Part Number:

HU: HEADS UP
 -
ISSSL-05: Infant Size, Small Height, Short Arms, Standard Foam, Lycra Cover, Paediatric 120 mm Pad **-05**
 +
AX7010: AXYS Mounting System
 +
M2500: AXYS Mounting Bracket

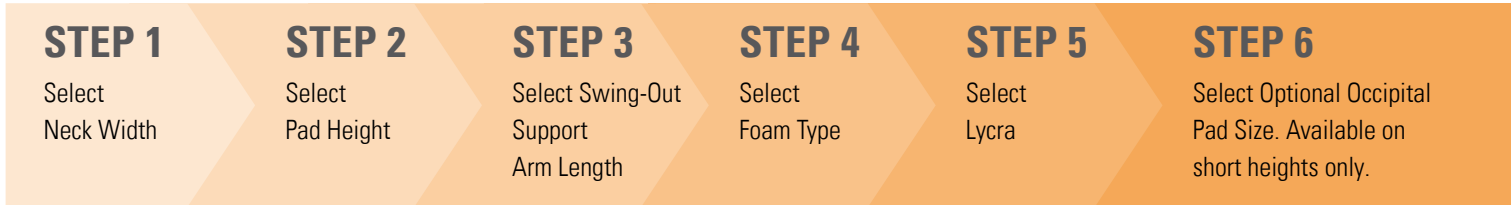

STEP 1		Neck Width							
		Infant (71 mm)		Small (89 mm)		Medium (104 mm)		Large (135 mm)	
		I		S		M		L	
STEP 2		Pad Height							
		Tall				Short			
		T				S			
STEP 3		Swing-Out Arm Length							
		Short				Long			
		S				L			
		Infant & Small		142 mm		185 mm		Medium & Large	
STEP 4		Foam Type							
		Standard				Comfort			
		S				C			
		Infant 10 mm	Small 13 mm	Medium 15 mm	Large 18 mm	Infant 15 mm	Small 15 mm	Medium 20 mm	Large 23 mm
STEP 5		Lycra (Neoprene)							
		L							
STEP 6	NOTE: After step 6 your smart part number for the head support is complete. Please proceed to step 7 and 8 and add those part numbers separate from the smart part #.	Pad Size (Optional)							
		Paediatric Pad 127 mm		Adult Pad 152 mm		Plush Pad 203 mm		Plush Pad 254 mm	
		-05		-06		-08		-010	

STEP 7

Select
Mounting System

STEP 8

Select
Mounting Bracket

NOTE:

Add both part numbers separate
from the smart part number

		MOUNTING SYSTEM					
		AXYS	ONYX	LINX	PRO	COBRA	COBRA XTRA FLIP BACK
STEP 7		AX7010	ADULT: OX7010 PAEDIATRIC: OX7030	LX7000	ADULT: PRC7010 PAEDIATRIC: PRC7030	ADULT: CRBA7010 PAEDIATRIC: CRBA7030 EARLY INTERVENTION: CRBA7080	ADULT: CRBA5010 PAEDIATRIC: CBRA5030 EARLY INTERVENTION: CBRA5080
		MOUNTING BRACKET					
STEP 8	Detachable	M2500	M2100-WB	M2300	M2200-WB	COBRA Hardware System includes detachable mounting bracket.	
	Swing away	M5500	M5100	M5300	M5200	Select COBRA Flip Back Hardware System for swing away capability.	

NOTE:

Chin prompt included

Attaching Lateral Facial Pads and Anterior
Supports could add to this systems versatility
(See page 19, Contoured Cradle)



HEADS UP | Ordering Guide

Heads Up Pads				
Large				
Short				
Long / Tall				
Medium				
Short				
Long / Tall				
Small				
Short				
Long / Tall				
Early Intervention				
Short				
Long / Tall				

NOTE: Measurements may vary due to foam variance.

CUSTOM SOLUTIONS | Options & Accessories

Mini Joystick Mount

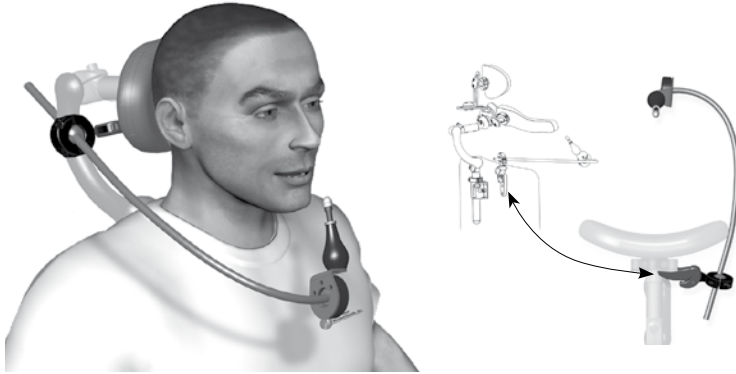

The Mini Joystick Mount facilitates precise placement of the joystick through two fully rotational locking joints while maintaining the ability to swing out-of-the-way. The single finger lever release mechanism automatically re-locks in place when returned to the adjusted position. The curved mounting rod allows for both length and rotational adjustment. The system allows mounting options either directly to a Whitmyer head support or to the back of the seating system. LM115 lateral mount ordered separately. Mini joystick not included.

PART NUMBERS:

LM1094	Mini Joystick Mount
LM1092	Mini Joystick Mount w / PLUSH Interface
LM1093	Mini Joystick Mount w / CCS Interface

Anterior Ballrod

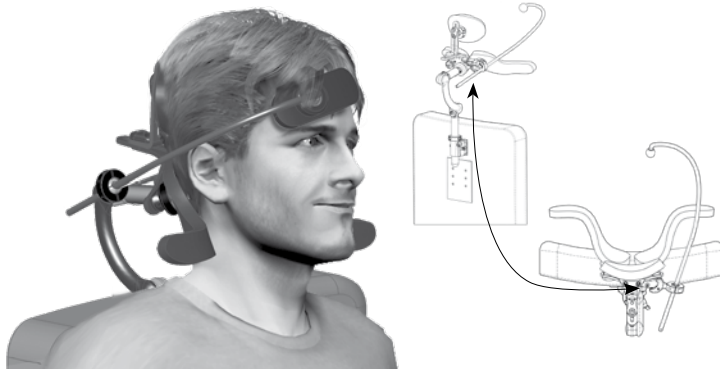

The Anterior Ballrod allows the precision placement of a positioning pad or switch at or about a person's forehead. It can be mounted from the user's right or left side or from straight over the top and provides consistent placement of pad or switch while maintaining sufficient clearance between the users head and hardware. The swing away mounting bracket features a single finger release mechanism that automatically locks in place when returned to the pre-adjusted position. LM115 lateral mount and pad ordered separately.

PART NUMBERS:

LM2094	Anterior Ballrod for S.O.F.T.
LM2092	Anterior Ballrod w / PLUSH Interface
LM2093	Anterior Ballrod w / CCS Interface

Flex Interface Bracket

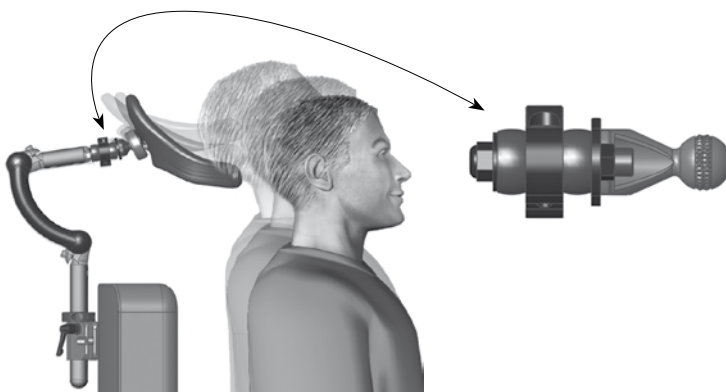

The Flex Interface Bracket provides upward flex, travel, and return when the head support is extended against. This dynamic motion assists in maintaining head support contact throughout the user's extensor pattern. The Flex Interface Bracket utilises elastomeric bushings engineered to supply the correct resistance-to-force while allowing the head support to return to the adjusted position. Used as an interface bracket between the head support mount and contact surface, the Flex Interface Bracket can be used with most Whitmyer head support accessories.

PART NUMBER:

M9450	Flex Interface Bracket
--------------	------------------------

CUSTOM SOLUTIONS | Options & Accessories

T-bar Occipital Mount

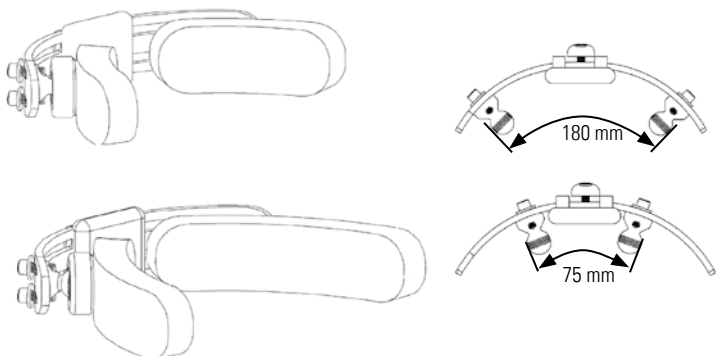

T-bar pads placed laterally correct or block lateral flexion or rotation patterns. Bilateral LFC with pads are designed for correction, or blocking of rotation or for maintaining midline head posture. Lateral flexion deviation can be adjusted by applying pads unilaterally. Pads should imitate hand placement during evaluation and/or simulation. Avoid direct pressure on the temple or the area near the eyes and ears.

PART NUMBERS:

PLT15L	T-bar with short pads
PLT20L	T-bar with long pads

Whit Kit



This valuable evaluation tool lets you explore optimal head support solutions. Packed in a sturdy rolling case with telescoping handle, the Whit Kit allows you to transport a full selection of pads, accessories, and mounting options. This unit was designed to aid in the proper selection and application of Whitmyer head supports. The Whit Kit ships complete with a universal "Quick Mount" that allows you to do head support fittings without modifying your client's chair. Its 300 mm - 600 mm range of attachment means it will fit most wheelchairs. Whit Kits are priced very aggressively and are sold at non-discounted dealer prices only.

PART NUMBER:

KIT-100	Whit Kit
----------------	----------

PRO Off-set Mounting System

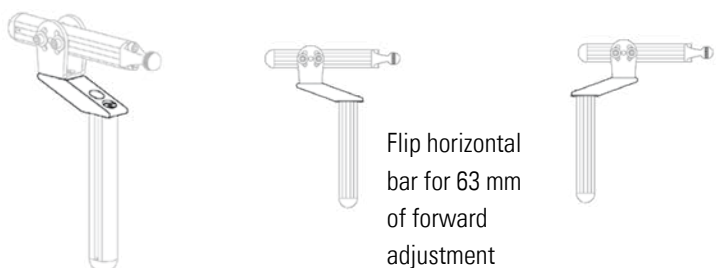

PRO system off-set bracket provides 63 mm of rearward adjustment to the horizontal bar. Flipping the horizontal bar will also allow for 63 mm of forward adjustment.

PART NUMBER:

PRC7070	PRO Off-set Mounting System
----------------	-----------------------------

Imperial Tool Kit

PART NUMBER:

T 2500	Imperial Tool Kit
---------------	-------------------

CUSTOM SOLUTIONS | Mounting Options

Universal Swing away Mount

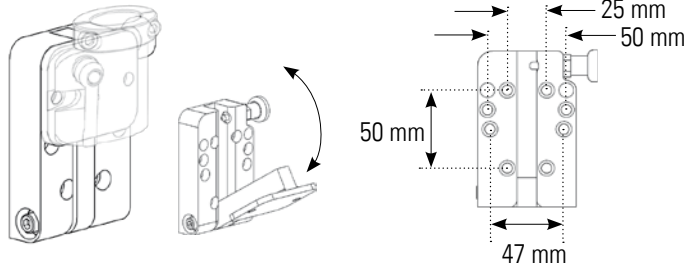

Whitmyer detach brackets attach to our universal swing away mount. When attached to the swing away mount, the assembly becomes a combination detach/swing away mounting bracket.

PART NUMBER:

M5000

Universal Swing away Mount

Quick Mount

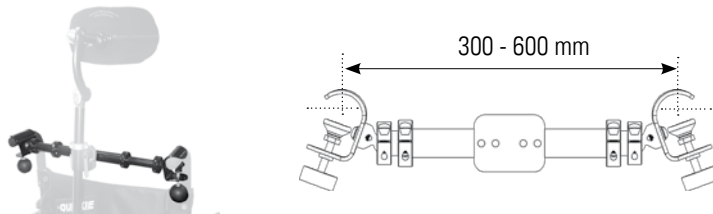

Whitmyer Quick Mount universally attaches head supports to any wheelchair back design without drilling or inserting T-nuts. Utilising the wheelchair canes as attachment points, the Quick Mount clamps adjust for angled canes or push handles and will accommodate chair widths from 300 - 600 mm.

PART NUMBER:

M7000

Quick Mount

Plastic Shell Back Interface Plate

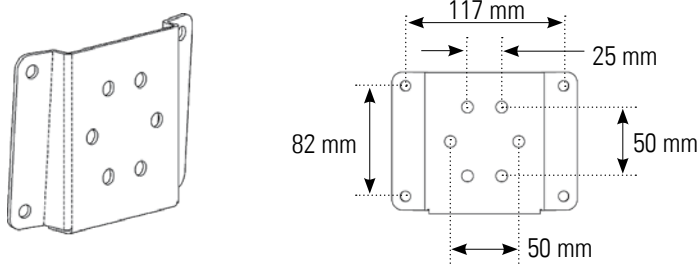

The Plastic Shell Back Interface provides a flat surface to attach mounting brackets to mobility devices with curved backs. It also serves as a reinforcing plate to distribute forces across a larger mounting area.

PART NUMBER:

M1010

Plastic Shell Back Interface Plate

Slide Mount

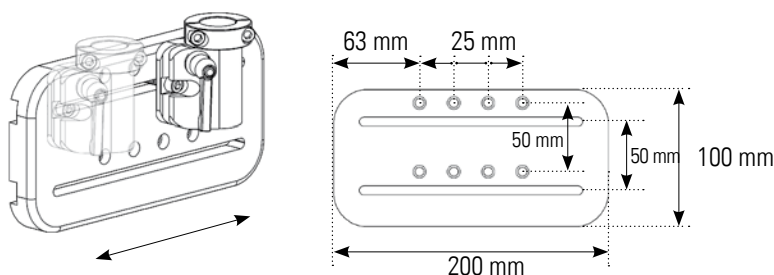

This slotted plastic plate allows the headrest/head support to be positioned in a more perpendicular fashion behind the head of individuals who present with a significant amount of asymmetry. The plate bolts into the chair's existing hole pattern and allows 100 mm of movement left or right. Perfect for trying off-set head support locations, adjusting for misplaced T-nut locations and relocating the head support to be more in line with the direction of applied forces.

PART NUMBER:

M7010

Slide Mount

TECH INFO | AXYS Mounting System

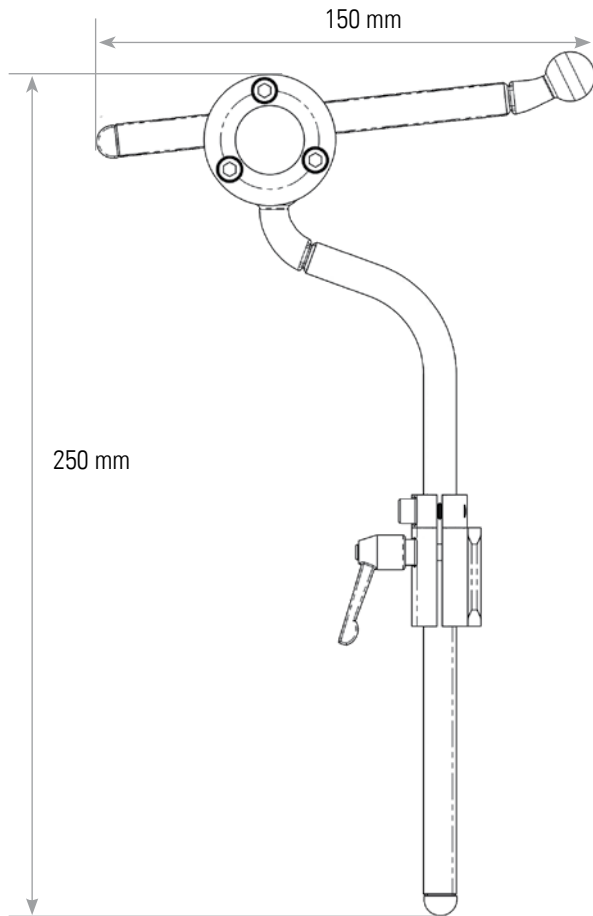

The **AXYS** Mounting System is a proven, economical hardware option. A black chrome finish combined with a small profile 12.5 mm steel square rod presents a compact, aesthetically pleasing mounting solution. Designed for ease of adjustment, and simple modifications. This system is compatible with all Whitmyer accessories.

Adult AXYS Mounting System without pad(s) part # AX7010

Special Considerations:

Rotate horizontal rod 180° for increased pad angle adjustment
 Rearward off-set vertical rod available for users with thinner backs.
 Square vertical rod interface available.

Material: Steel

Finish: Black chrome plated

Profile/Size:

12.5 mm Square Rod
 120 mm Horizontal rod & 250 mm vertical rod

Adjustment Point:

Fixed collar clamp at vertical/horizontal rod interface
 Measurement changes when applying base plates:
 add 45 mm for S.O.F.T. base plate

Mounting Brackets:

Detachable: M2500
 Swing away: M5500
 Material: Aluminum extrusion
 Finish: Black anodized

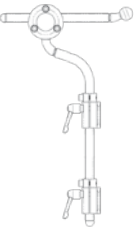
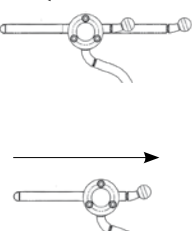
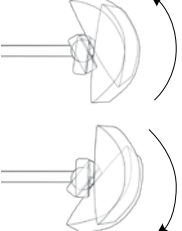
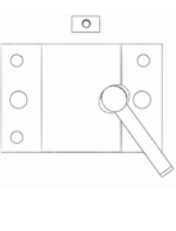
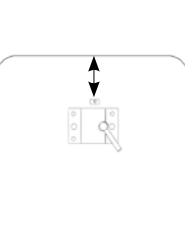
					
	Height	Horizontal Depth	Pitch	Mounting Holes	Mount Placement
Standard	250 mm	150 mm	30°	47 - 50 mm on centre	75 mm minimum from top of chair back

TECH INFO | LINX Mounting System

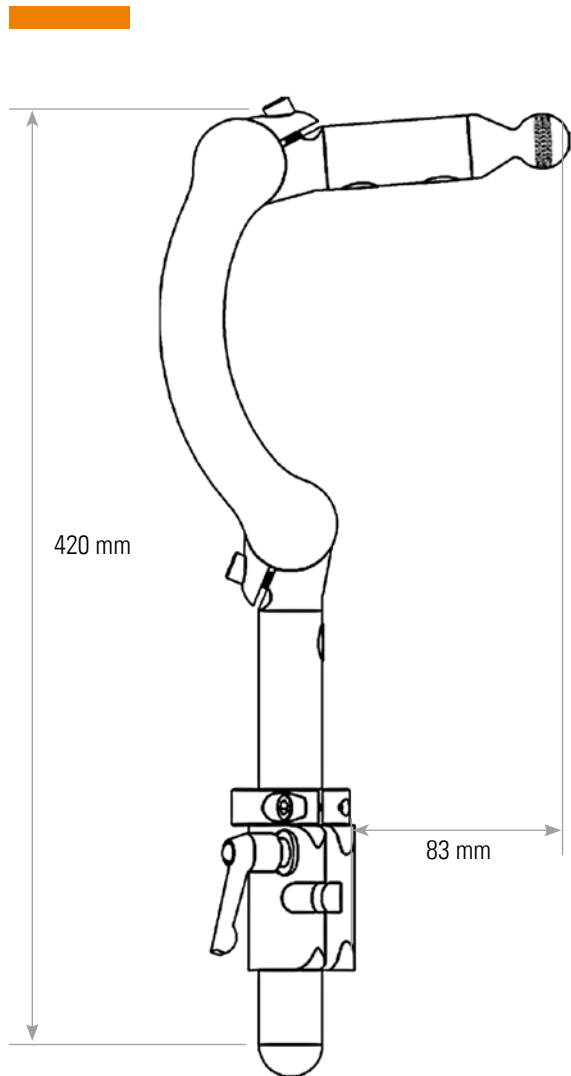

The **LINX** Mounting System features the latest concept in contemporary head support mounting hardware. Combining two simple, unique points of adjustment allows full anterior/posterior fluid movement, creating an infinite range of support surface placement. Satin black tubing with contrasting polished aluminum clamps and knurled mounting ball ensures stay-in-place adjustments with a stylish look.

LINX Mounting System without pad(s) part # LX7000

Special Considerations:

No rearward protrusion and two easily accessible adjustment points simplify the fitting process.

Material:

Extruded & cast aluminum and stainless steel
 Finish: clamps, clear anodised – knurled ball, clear polished, tubes, black mat anodised

Profile/Size: 22 mm tubing

Adjustment Point:

Three piece interlocking pivot system
 Measurement changes when applying base plates:
 add 45 mm for S.O.F.T. base plate

Mounting Brackets:

Detachable: M2300
 Swing away: M5300
 Material: Aluminum extrusion
 Finish: Black anodised

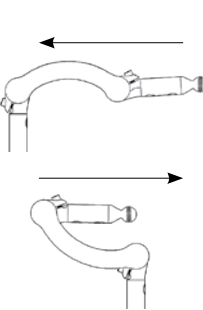
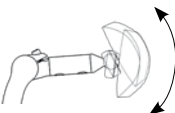
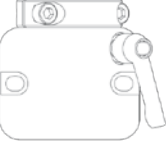
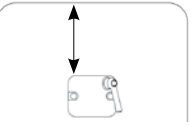
					
	Height	Horizontal Depth	Pitch	Mounting Holes	Mount Placement
Standard	178 mm	215 mm Forward 20 mm Rearward	30°	47 - 50 mm on centre	150 mm minimum from top of chair back

TECH INFO | PRO Mounting System

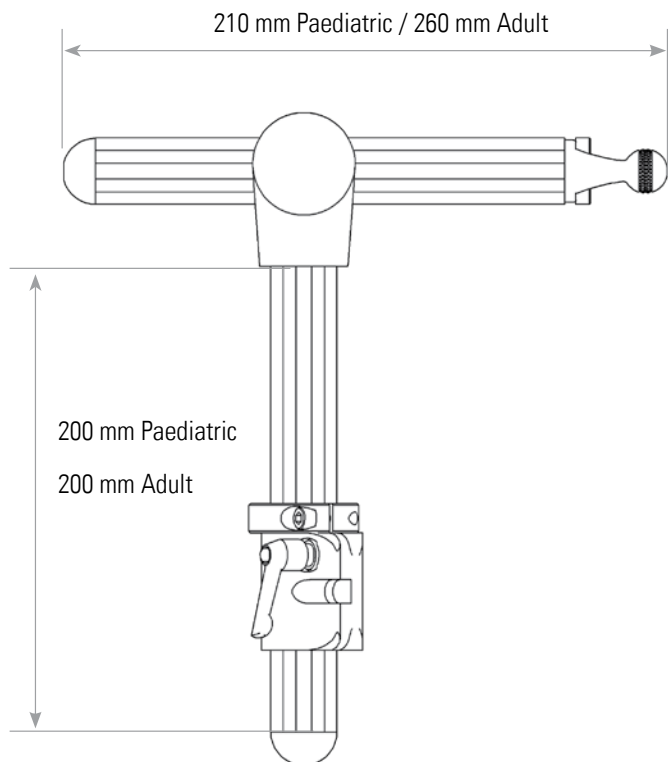

The **PRO** Mounting System is a proven hardware option for demanding applications. This Mounting System is ideal for use when client strength or strong tonal patterns are an issue. Perfect for institutional environments.

Adult PRO Mounting System without pad(s)
part # PRC7010

Paediatric PRO Mounting System without pad(s)
part # PRC7030

Special Considerations:

Rearward Protrusion: horizontal bar easily trimmed
Rearward off-set bracket available for thinner backs

Material: Aluminum
Finish: Black anodised

Profile/Size:
Adult & Paediatric 30 mm custom extrusion

Adjustment Point:
Horizontal pivot
Measurement changes when applying base plates:
add 30 mm for S.O.F.T. base plate

Mounting Brackets:
Detachable: M2200
Swing away: M5200
Material: Aluminum
Finish: Black anodised

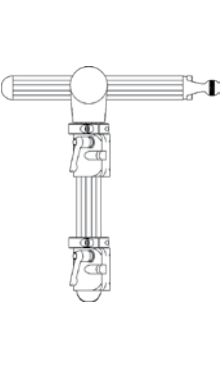
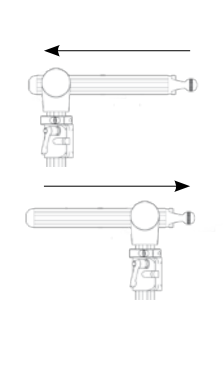
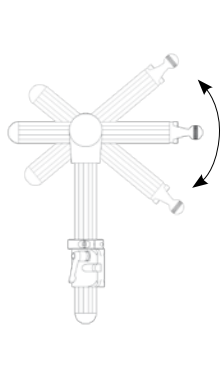
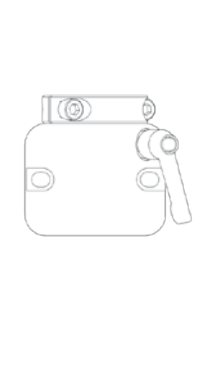
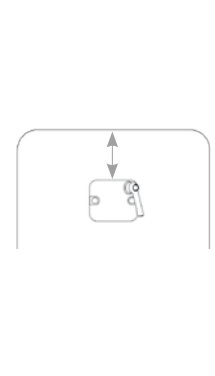
					
	Height	Horizontal Depth	Pitch	Mounting Holes	Mount Placement
Adult	150 mm	38 mm Forward 200 mm Rearward	45°	47 - 50 mm on centre	75 mm minimum from top of chair back
Paediatric	150 mm	38 mm Forward 150 mm Rearward	45°	47 - 50 mm on centre	75 mm minimum from top of chair back

TECH INFO | ONYX Mounting System

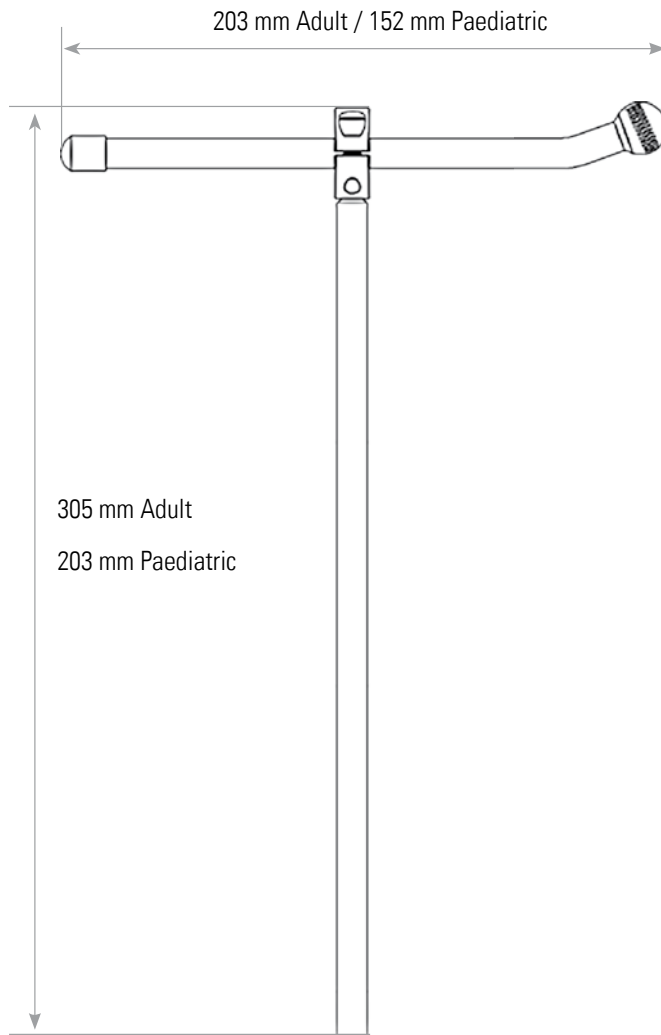

The **ONYX** Mounting System is a compact solution that features a black chrome finish combined with a small profile steel rod. It was designed for ease of adjustment and simple modifications.

ONYX Mounting System without pad(s)

part # adults: OX7010

part # paediatric: OX7030

Special Considerations:

Rotate horizontal rod 180° for increased pad angle adjustment.
Rearward off-set vertical rod available for users with thinner backs.
Square vertical rod interface available.

Material: Steel

Finish: Black chrome plated

Adjustment Point:

Fixed collar clamp at vertical/horizontal rod interface.
Measurement changes when applying base plates:
add 45 mm for S.O.F.T. base plate

Mounting Brackets:

Detachable: M2100 Swing away: M5100

Material: Aluminium extrusion

Finish: Black anodised

	Height	Horizontal Depth	Pitch	Mounting Holes	Mount Placement
Adult	279 mm	25 mm min 203 mm max	30°	48 mm to 51 mm on centre	76 mm min from top of chair back
Paediatric	178 mm	25 mm min 152 mm max	30°	48 mm to 51 mm on centre	76 mm min from top of chair back

TECH INFO | COBRA Mounting System

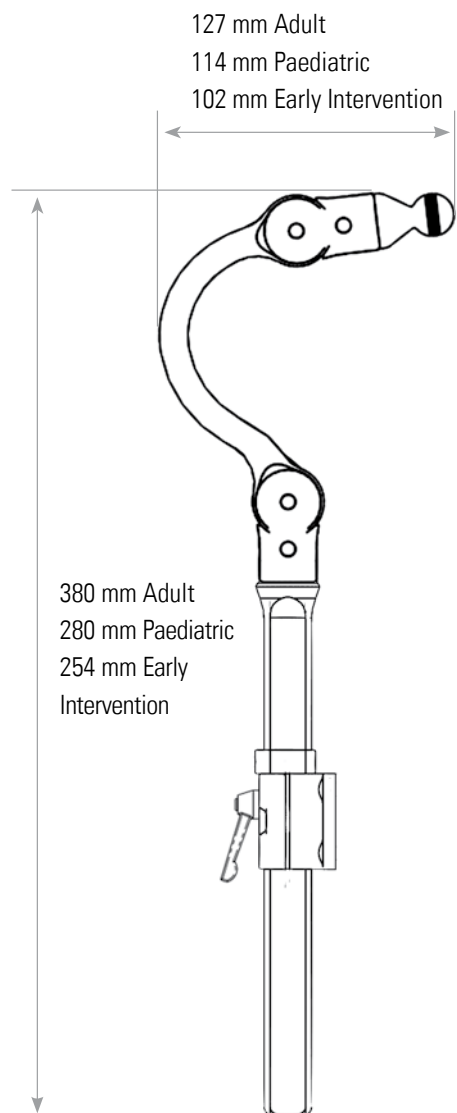

The **COBRA** Mounting System incorporates a sleek and unobtrusive design that eliminates protrusion toward the rear of the chair. With a superior strength and positioning range, the COBRA is available in three sizes. The components are modular and easily changed in the field to enable exact positioning of the support pad, even if the user's head position changes over time.

Special Considerations:

- All COBRA Mounting Systems are shipped with a detachable mounting bracket.
- The top of the COBRA vertical rod has an adjustable, locking rotator assembly to allow rotational adjustment as well as front-to-rear adjustment of the shepherd's crook-shaped forward adjustment rod (neck).
- Low profile design does not impede access from behind.

Material: Aluminium

Finish: Black anodised

Adjustment Point:

Two point adjustable, locking rotator assembly at intersection of vertical rod and neck plus one point adjustment at pad interface bracket.

Mounting Brackets:

Detachable mounting bracket included with all COBRA Mounting Systems.

Material: Aluminium extrusion

Finish: Black anodised

	Height	Horizontal Depth	Pitch	Mounting Holes	Mount Placement
Adult	165 mm	165 mm Forward 50 mm Rearward	30°	48 - 51 mm on centre	127 mm minimum from top of chair back
Paediatric	89 mm	127 mm Forward 38 mm Rearward	30°	48 - 51 mm on centre	127 mm minimum from top of chair back
Early Intervention	89 mm	100 mm Forward 12 mm Rearward	30°	48 - 51 mm on centre	127 mm minimum from top of chair back

TECH INFO | COBRA XTRA Flip Back Mounting System

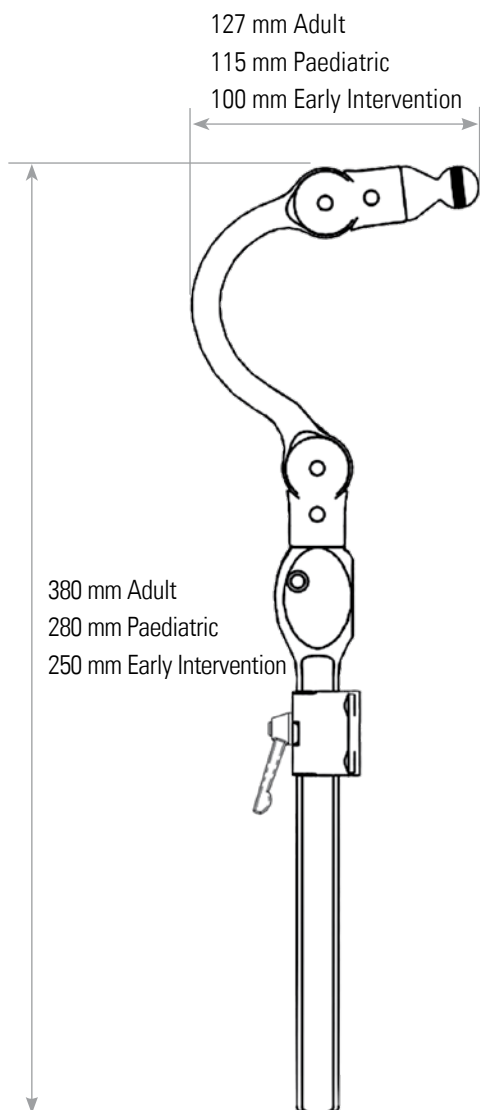

The **COBRA XTRA** Flip Back Mounting System is operated by a single push-button on the side of the bracket and neatly flips the assembly back behind the wheelchair back. With superior strength and positioning range, the COBRA XTRA Flip Back Mounting System is available in Small (Early Intervention and Paediatric), Medium (Paediatric), and Large (Adult). The components are modular and easily changed in the field to enable exact positioning of the head support pad – even if the user's head position changes from the time of the initial prescription.

Special Considerations:

All COBRA XTRA Flip Back Mounting Systems are shipped with a detachable mounting bracket but without pad(s) are:

Early Intervention Part # CBRA5080

Paediatric Part # CBRA5030

Adult Part # CBRA5010

The top of the COBRA XTRA vertical rod has an adjustable, locking rotator assembly to allow rotational adjustment as well as front-to-rear adjustment of the shepherd's crook-shaped forward adjustment rod (neck)

Low profile design does not impede access from behind

Material: Aluminum

Finish: Black Anodised

Profile Size: 12 mm x 22 mm bar and 12 mm rod

Early Intervention 70 mm neck, 280 mm vertical Rod

Paediatric 115 mm neck, 280 mm vertical Rod

Adult 140 mm neck, 288 mm vertical Rod

Adjustment Point: Two point adjustable, locking rotator assembly at intersection of vertical rod and neck plus one point adjustment at pad interface bracket

Mounting Brackets:

Detachable mounting bracket included with all COBRA XTRA Flip Back Mounting Systems

Material: Aluminum extrusion

Finish: Black anodised

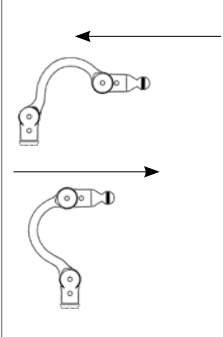
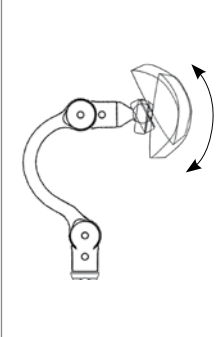
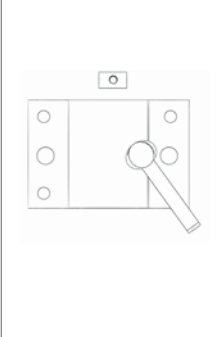
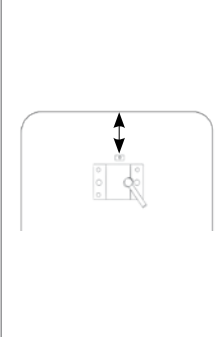
					
	Height	Horizontal Depth	Pitch	Mounting Holes	Mount Placement
Adult	140 mm	165 mm Forward 50 mm Rearward	30°	47 - 50 mm on centre	127 mm minimum from top of chair back
Paediatric	62 mm	127 mm Forward 38 mm Rearward	30°	47 - 50 mm on centre	127 mm minimum from top of chair back
Early Intervention	62 mm	100 mm Forward 12 mm Rearward	30°	47 - 50 mm on centre	127 mm minimum from top of chair back

TECH INFO | PLUSH Pads

Foam:

Dual density laminate:

Support layer 16 mm thick, latex free closed cell ethylene/propylene rubber blend with laminated self-adhesive flannel loop material for easy foam replacement (black).

Comfort layer:

19 mm thick, open cell polyurethane contact foam (white).

Panel:

Formed epoxy e-coated steel panel with laminated self-adhesive hook material for easy foam replacement.

Collar:

Universal 19 mm radius split collar, includes vinyl collar cover.

Cover:

Locking zippered Lycra cover, combination neoprene with laminated Lycra outer fabric and nylon inner fabric (black).





Cover Options:

Lycra fabric is standard.

NOTE:

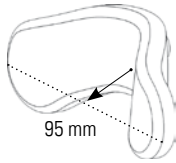
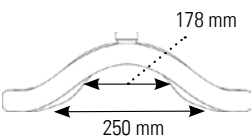
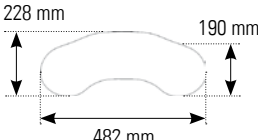
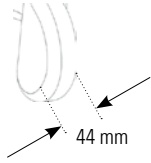
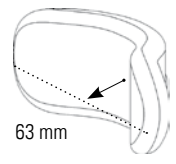
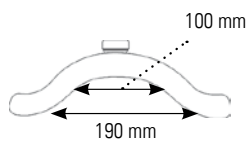
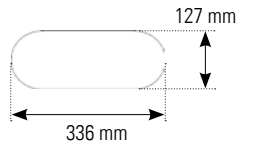
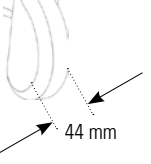
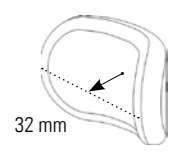
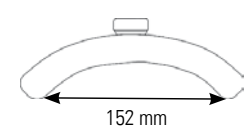
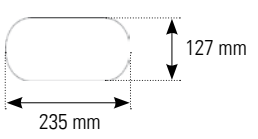
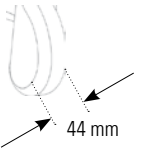
Measurements may vary due to foam variance.

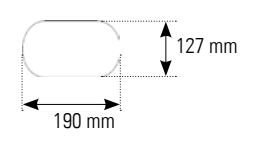
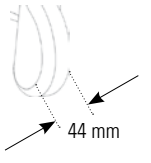
Washing Instructions: Hand wash in mild detergent and cool water. Lay flat to dry.

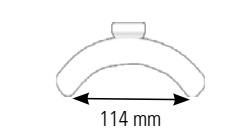
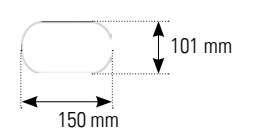
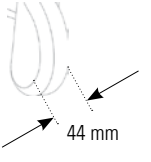
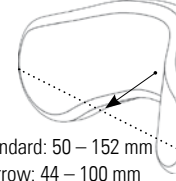
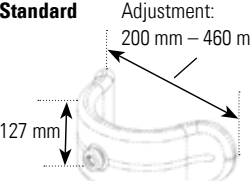
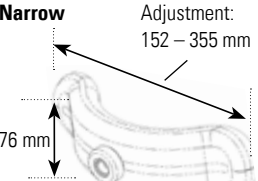
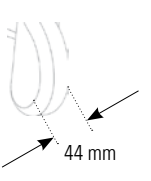
PLUSH Pads				
480 mm PLUSH P1900L				
350 mm PLUSH P1400L				
250 mm PLUSH P1000L				
200 mm PLUSH P800L				
150 mm PLUSH P600L				
Adjust-A-PLUSH Standard: P8088L Narrow: P8044L				

TECH INFO | Specialty PLUSH Pads

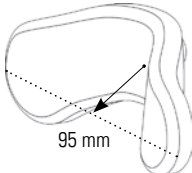
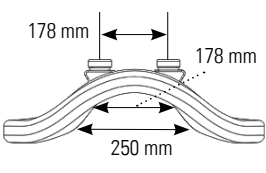
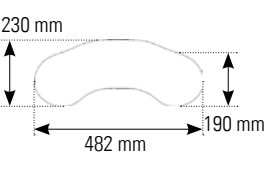
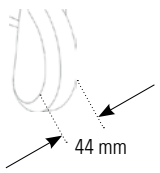
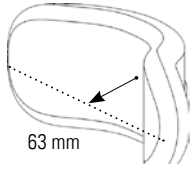
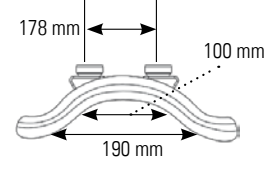
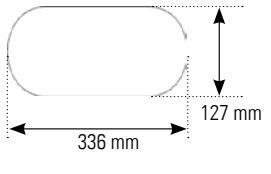
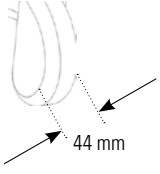
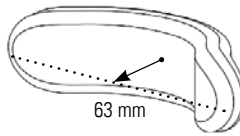
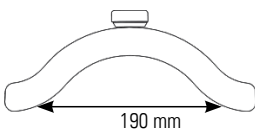
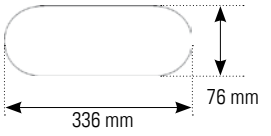
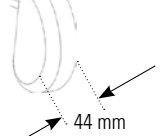
Specialty PLUSH Pads				
48 Dual PLUSH P1920L				
350 mm Dual PLUSH P1420L				
Narrow PLUSH P1205L				

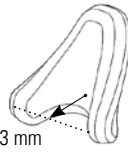
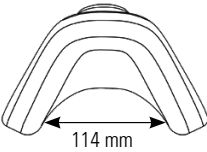
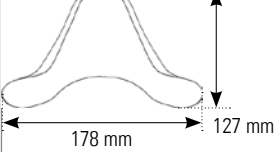
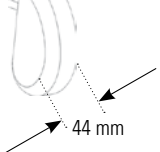
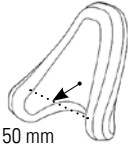
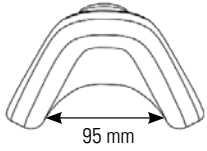
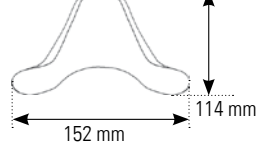
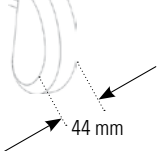
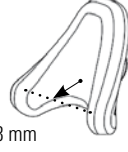
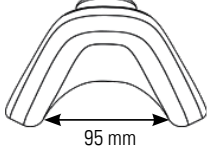
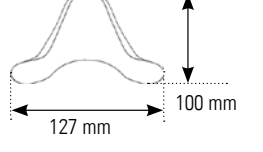
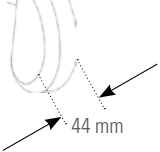
Specialty PLUSH C- PLUSH Pads				
Large C-PLUSH P4010L				
Medium C-PLUSH P3010L				
Small C-PLUSH P2010L				

TECH INFO | Occipital & Contoured Cradle Pads

Foam:

Latex free closed cell ethylene/propylene rubber blend with laminated self-adhesive flannel loop material for easy foam replacement.

Panel:

Formed epoxy e-coated steel panel with laminated self-adhesive hook material for easy foam replacement.

Collar:

Universal 19 mm radius split collar, includes vinyl collar cover.

Cover:

Locking zippered lycra cover, combination neoprene with laminated lycra outer fabric and nylon inner fabric (black).
Soft fleece cover only available for CUDDLES INFANT Headrest.





Cover Options:

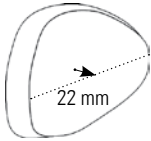
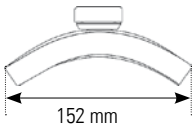
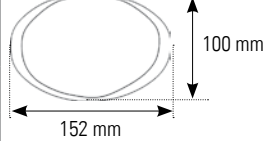
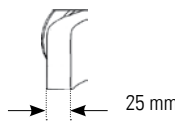
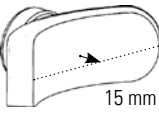
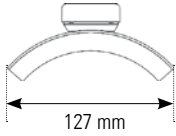
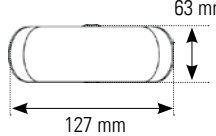
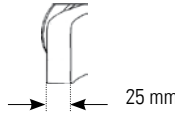
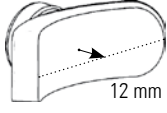
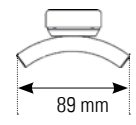
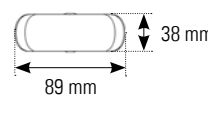
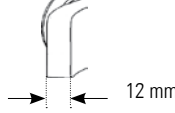

Lycra fabric is standard.
Soft fleece cover only available for CUDDLES INFANT Headrest.

NOTE:

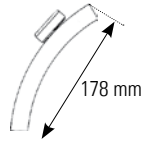
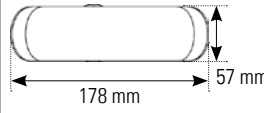
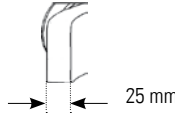

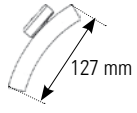
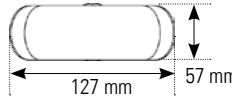
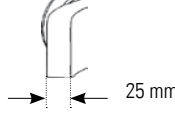

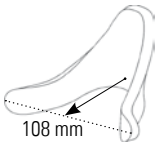
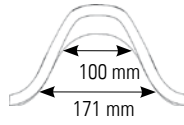
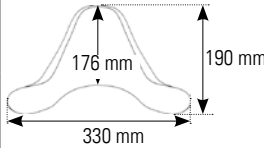
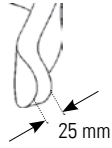

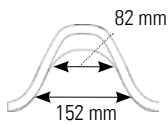
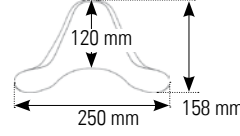
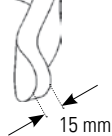
Measurements may vary due to foam variance.

Washing Instructions: Hand wash in mild detergent and cool water. Lay flat to dry.

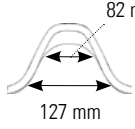
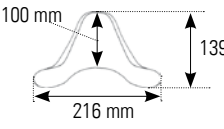
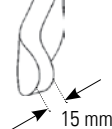
Occipital Pads				
Adult P600L				
Paediatric P500L-WB				
Infant INFT100				
Long T-bar PL20L1				
Standard T-bar PL15L1				

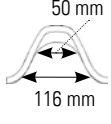
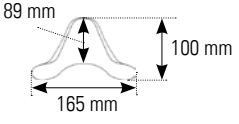
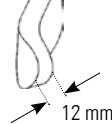
Contoured Cradle Pads			Continued on Page 43	
Large P400L				
Medium P300L				

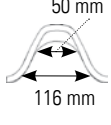
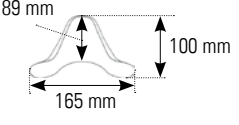
TECH INFO | Sub-occipital & Single Sub-occipital Pads

Contoured Cradle Pads Continued				
Small P200L	 57 mm	 82 mm 127 mm	 100 mm 216 mm 139 mm	 15 mm
Infant INFT200LSE	 38 mm	 50 mm 116 mm	 89 mm 165 mm 100 mm	 12 mm
Cuddles Infant INFT200	 38 mm	 50 mm 116 mm	 89 mm 165 mm 100 mm	 12 mm

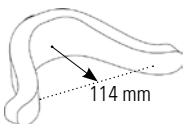
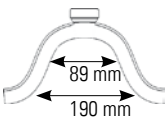
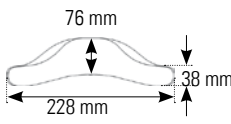
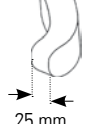
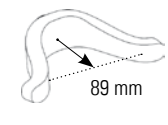
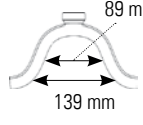
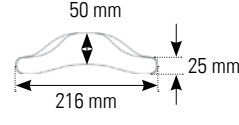
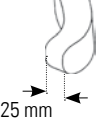
Single Sub Occipital Pads				
Large PSS01L	 114 mm	 89 mm 190 mm	 76 mm 228 mm 38 mm	 25 mm
Small PSS03L	 89 mm	 89 mm 139 mm	 50 mm 216 mm 25 mm	 25 mm

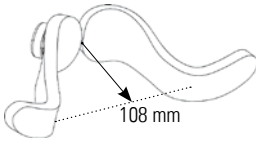
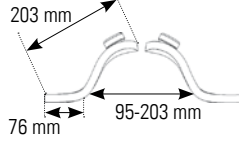
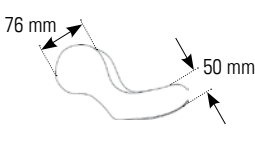
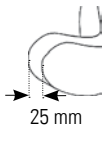
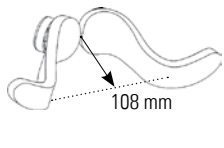
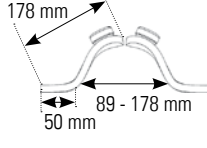
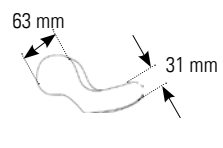
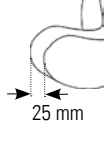
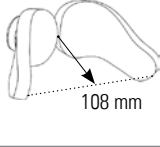
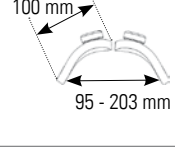
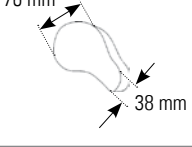
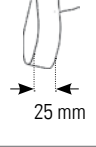
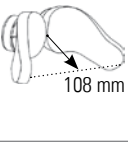
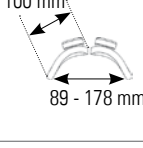
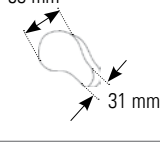
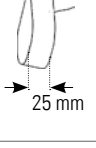
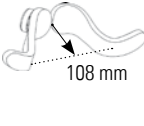
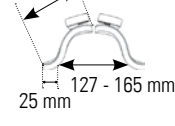
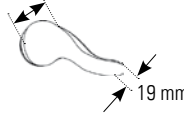
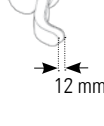
Sub Occipital Pads				
Size-1 PS01R / PS01L	 108 mm	 203 mm 76 mm 95-203 mm	 76 mm 50 mm	 25 mm
Size-3 PS03R / PS03L	 108 mm	 178 mm 89 - 178 mm 50 mm	 63 mm 31 mm	 25 mm
Size-2 PS02R / PS02L	 108 mm	 100 mm 95 - 203 mm	 76 mm 38 mm	 25 mm
Size-4 PS04R / PS04L	 108 mm	 100 mm 89 - 178 mm	 63 mm 31 mm	 25 mm
Infant INFT-R / INFT-L	 108 mm	 100 mm 25 mm 127 - 165 mm	 44 mm 19 mm	 12 mm

TECH INFO | S.O.F.T. Single Sub-occipital Base Plate Assembly

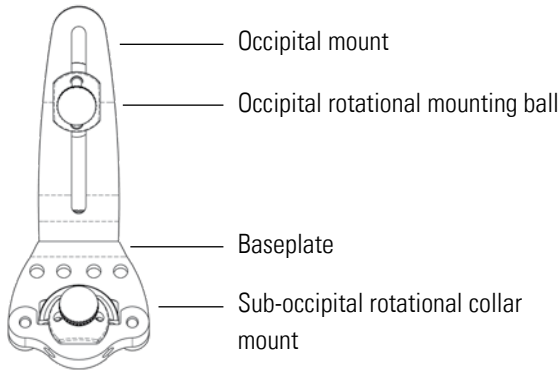

The universal design of the Single Sub-occipital base plate assembly fits on to the horizontal rod of any Whitmyer Mounting System. The rotational collar mount allows a full range of tilt and rotation for the complete base plate assembly. Mounted on the occipital bracket, the occipital mount ball allows height and rotational adjustment. Independent anterior/posterior adjustment is achieved through the slotted design of the occipital mount.

M9275					
	Rotational	Forward Rotation	Rearward	Mount Reversed	Height
Adjustment	30°	30°	57 mm	127 mm	50 mm



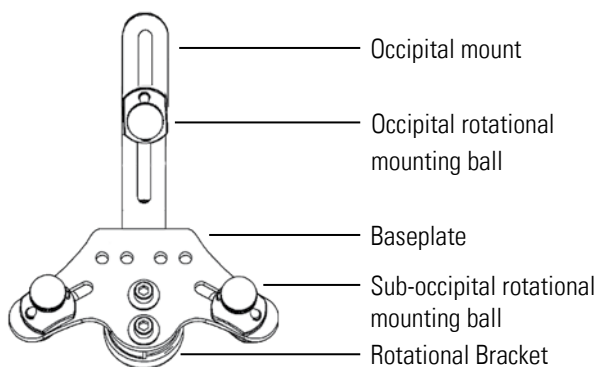

TECH INFO | S.O.F.T. Adult and Paediatric Base Plate Assembly





The universal design of the S.O.F.T. base plate assembly fits on to the horizontal rod of any Whitmyer Mounting System. Designed for three pad configurations, the rotational collar mount allows a full range of tilt and rotation for the complete base plate assembly. Width adjustable sub-occipital rotational mounting balls ensure even pressure distribution when positioning the pads. The height adjustment of the rotational mount ball, along with the separate depth adjustability of the occipital mount ensure correct anatomical fit for correction/control and support.

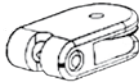



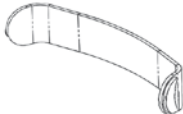
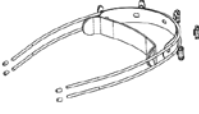
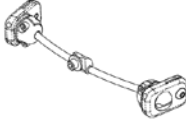

M9375					
	Rotational	Forward Rotation	Rearward	Mount Reversed	Height
Adjustment	30°	30°	57 mm	127 mm	50 mm

REPLACEMENT PARTS | Anterior Supports

					
DFS	Terry Against Skin	Neoprene Against Skin	Anterior Support Interface	DFS Pulley Housing	Cord and tension adjusters
Adult	D1017	D1018	D1010	D1015	D1013
Paediatric	D1028	D1027	D1010	D1015	D1013

				
DFS²	Neoprene Against Skin	Strap and Support	Crossbar Assembly	Hardware Package
Adult	D2018	DQ1010	DQ-CBA1	DQ-HDW
Paediatric	D2027	DQ3010	DQ-CBA3	DQ-HDW

REPLACEMENT PARTS | Lateral Facial Components

							
	Spot	Standard	Long	Oval	Large "C"	Medium "C"	Small "C"
Part Number	PL10L	PL15L	PL20L	P600L	PL30L	PL35L	PL40L
Size	50 mm	60 x 127 mm	60 x 178 mm	100 x 150 mm	50 x 152 mm	15 x 127 mm	12 x 100 mm

					
	Swing away Mount	Split Ball	Lateral Ballrod	PLUSH Lateral Interface Plate	CCS Lateral Interface Plate
Part Number	LM115	LM1100	LM1090	LM-PL	LM-CCS
Size	-	12 mm	279 mm	-	-







TECH INFO | Replacement Foam & Covers

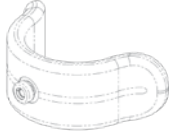
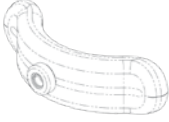

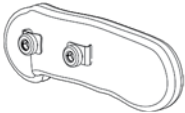

Foam and covers are items that experience wear and should be periodically inspected, washed and replaced. Whitmyer offers a Lycra cover and for the CUDDLES INFANT Headrest also a soft fleece cover. Refoam kits consisting of foam and self-adhesive hook material are available for all Whitmyer pad configurations.

NOTE: Our current refoam kits will also retrofit original S.O.F.T. pad systems (bright chrome). However, to ensure proper fit, new zippered covers must be purchased for these systems.

PLUSH Pads					
					
	480 mm PLUSH	350 mm PLUSH	250 mm PLUSH	200 mm PLUSH	150 mm PLUSH
Foam	PF1900	PF1400	PF1000	PF800	PF605
Cover	PC1900L	PC1400L	PC1000L	PC800L	PC605L





PLUSH Pads		
		
	Standard	Narrow
Foam	PF8088	PF8044
Cover	PC8088L	PC8044L

PLUSH Pads						
						
	480 mm DUAL PLUSH	350 mm DUAL PLUSH	300 mm NARROW PLUSH	Large "C" PLUSH	Medium "C" PLUSH	Small "C" PLUSH
Foam	PF1900	PF1400	PF1205	PF4010	PF3010	PF2010
Cover	PC1900L	PC1400L	PC1205L	PC4010L	PC3010L	PC2010L





PLUSH Pads					
					
	Large	Medium	Small	Infant	CUDDLES INFANT
Foam	PF400	PF300	PF200	INFTF200	INFTF200
Cover	PC400L	PC300L	PC200L	INFTC200-L	INFTC200F

TECH INFO | Replacement Foam & Covers





Single Sub-occipital Pads

				
	SS10	SS8	SS4	SS3
Foam	PFSS10	PFSS8	PFSS4	PFSS3
Cover	PCSS10L	PCSS8L	PCSS4L	PCSS3L

S.O.F.T. Adult Pads

				
	S.O.F.T. 5	S.O.F.T. 1	S.O.F.T. 2	S.O.F.T. 8
Foam	PF5	PF1	PF2	PF8
Cover	PC5L	PC1L	PC2L	PC8L

S.O.F.T. Paediatric Pads

				
	S.O.F.T. 3	S.O.F.T. 6	S.O.F.T. 4	S.O.F.T. 7
Foam	PF3	PF6	PF4	PF7
Cover	PC3L	PC6L	PC4L	PC7L



For further information on the full specification, options and accessories, please refer to the order form. All information is subject to change without notification. Please consult Sunrise Medical with any queries you may have. If you are visually impaired, this document can be viewed in PDF format at www.SunriseMedical.eu.



Sunrise Medical

Thorns Road, Brierley Hill
West Midlands, DY5 2LD
Tel.: +44 (0) 845 605 66 88
Fax: +44 (0) 845 605 66 89
www.SunriseMedical.co.uk

